



# PIEZO SYSTEMS, INC.

65 Tower Office Park Woburn, MA 01801 • Tel: (781) 933-4850 • Fax: (781) 933-4743 • Web: www.piezo.com • E-mail: sales@piezo.com

## TABLE OF CONTENTS - CATALOG #7C

### ENGINEERING

**OEM COMPONENT DEVELOPMENT** 2-3

### PRODUCTS

#### ELECTRONICS

Piezo Linear Amplifier	4-5
Small Low-cost Linear Amplifier	6-7
Proportional Voltage Booster	8
DC to AC Inverter Drive Circuit	9-10

#### FANS AND RESONATORS

Piezoelectric Chopper	11
Piezoelectric Fans	
■ 115VAC/60Hz Version	12
■ Low Voltage DC Version	13

#### MOTION INSTRUMENTS

1 - Axis Mirror Tilters, $\pm 0.35^\circ, \pm 55^\circ, \pm 0.75^\circ, \pm 95^\circ$	14-15
2 - Axis Mirror Tilter, $\pm 1.6^\circ$	16-17

#### DESIGN AND PROTOTYPING

Piezoelectric Motor/Actuator Kit	18
Piezoelectric Generator/Sensor Kit	19

#### TRANSDUCERS (MOTOR / ACTUATORS AND GENERATOR / SENSORS)

Introduction to Piezo Transducers	20-23
1-Layer Piezo Transducers (Single Sheets)	
■ 5A Type Piezoceramic	24-25
■ 5H Type Piezoceramic	26
2-Layer Piezo <b>Benders &amp; Extenders</b>	
Basic Transducers, <b>Benders &amp; Extenders</b>	27-28
■ Standard Brass Reinforced (Actuators & Sensors)	29-33
■ High Performance	33-35
■ Non-Magnetic	36
■ High Strength Stainless Steel Reinforced	37
Pre-mounted & Wired, <b>Benders &amp; Extenders</b>	
■ Quick-Mounts (Actuators & Sensors)	38-44
■ Double-Quick-Mounts (Actuators & Sensors)	45-51
Circular Bending Disks	52
4-Layer Piezo Benders	53
Multi-Layer Low Voltage Piezo Stacks	54--55
Solder / Flux Kit	56

### PIEZOCERAMIC APPLICATION DATA

Introduction to Piezoelectricity	57-59
Motor Transducer Relationships	60
Generator Transducer Relationships	61
Typical Thermal Properties of Piezoceramic	62

**SERVICE AND WARRANTY:** All Piezo Systems, Inc. products are warranted against defective materials and workmanship. This warranty applies for a period of time of one year from the date of delivery to the original purchaser. Any instrument or part that is found within the one year period not to meet these standards, will be repaired or replaced. No other warranty is expressed or implied. **NOTE:** Prices and specifications subject to change without notice.

### OEM COMPONENT DEVELOPMENT



**HIGH FREQUENCY TUNING FORK**

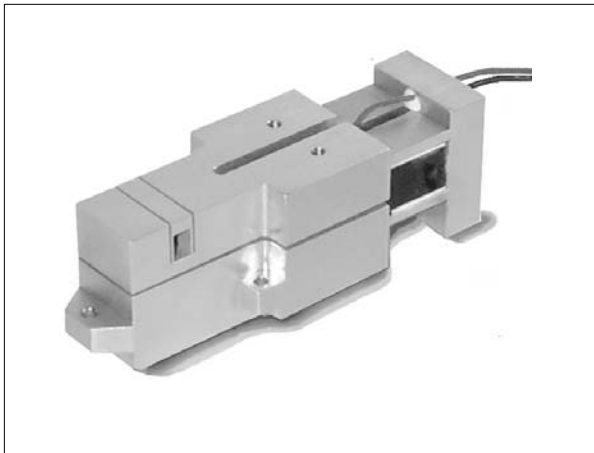

**HIGH OUTPUT ACTUATOR**

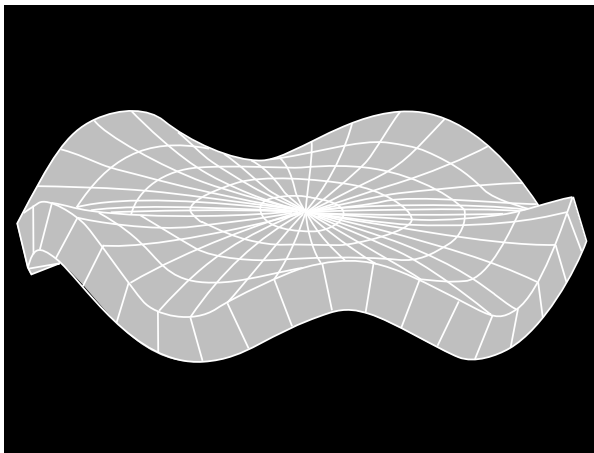

**FEA MODELING**

#### CUSTOMER SPECIFICATIONS

Piezoceramic actuator design is based on customer specifications which include as a minimum:

- Motion and force requirements
- Space available
- Voltage available
- Thermal operating range
- Frequency operating range or response time

Dynamic sensor design is based on customer specifications which include as a minimum:

- Voltage and current requirements
- Space available
- Force or strain available
- Thermal operating range
- Frequency range or transient response time

#### ACTUATOR & SYSTEM DESIGN

Using extensive computer software and experience, Piezo Systems can move quickly from your specifications to a complete optimized design and prototype. The geometry, electroactive material, internal lamination, polarization, electrode configuration, mount, power take-off, and production process is designed to ensure repeatable and reliable performance.

Piezo Systems can also design and build the electronic system to drive or monitor the transducer, and fabricate (or mold) the structure to which the piezo is mounted.

#### OEM PRODUCT DEVELOPMENT

Piezo Systems Inc. offers engineering services for custom OEM component development. Our experience allows the elimination of potential design flaws which plague those unfamiliar with piezoceramic technology, especially in the areas of lamination bonding, flexure design, ceramic stress and fatigue criteria, thermal stability, mounting, power take-off attachments, electronic drive, testing, and evaluation. This service reduces the customer's need to dedicate highly qualified personnel during the development period, and development time is typically reduced from years to months. Financial and technical risks are minimized. The following phases are quoted on a fixed price basis:

- Analysis and Design Phase: Communication of specifications, analysis, and optimized design of transducer.
- Prototype Phase: Samples built to specification.
- Pre-production Phase: Pre-production samples for exhaustive testing.
- Production Phase: Production pieces at desired volume.



## AREAS OF EXPERTISE

### BENDING ACTUATORS & SENSORS

Piezo Systems specializes in manufacturing bending elements. A proprietary bonding process and ceramic qualifying program leads to consistent performance, high-strength, thermally stable, void free, multilayer laminations.

Advanced cutting techniques produce actuators with dimensional tolerances within  $\pm 0.01$  inch if necessary; chip free edges; non-linear shapes; and contamination free surfaces. Piezo Systems ships parts to performance specifications, not merely to dimensional tolerance. Our bending actuators are employed in piezo valves, choppers, modulators, fans, tunneling microscopes, and soil testers. Our bending sensors are used in implantable pacemakers and industrial equipment.

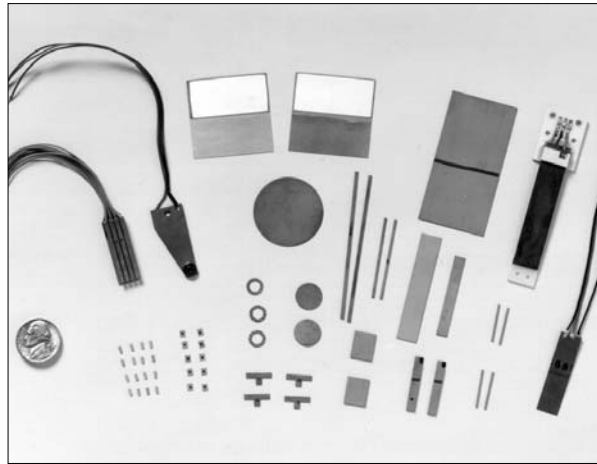

**BENDING ELEMENTS**

### RESONANT DEVICES

Resonant devices are an effective way of achieving high periodic motion at low voltage and power. Products designed to operate at a single frequency require special attention be paid to dimensional uniformity, material consistency, and process control. A careful balance is sought between minimizing strain on the piezoceramic and maximizing the dynamic amplitude. Energy losses due to internal dissipation, external attachments, and output loading are addressed.

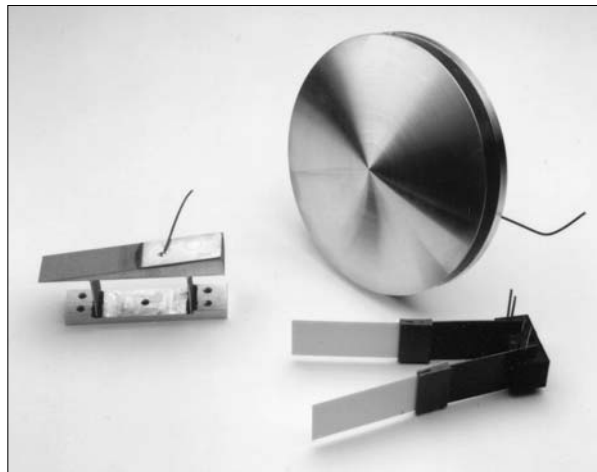

**RESONATORS**

### ULTRASONIC DEVICES

Ultrasonics, a special portion of the resonant spectrum, find extensive use over a wide range of application areas. These devices are designed according to the same principles guiding resonant devices. However, additional consideration is given to amplitude stability, power consumption, over-heating, resonance tracking, and electronic drive.

Piezo Systems has developed a monolithic construction which eliminates many of the problems associated with precompressed bolt together systems.

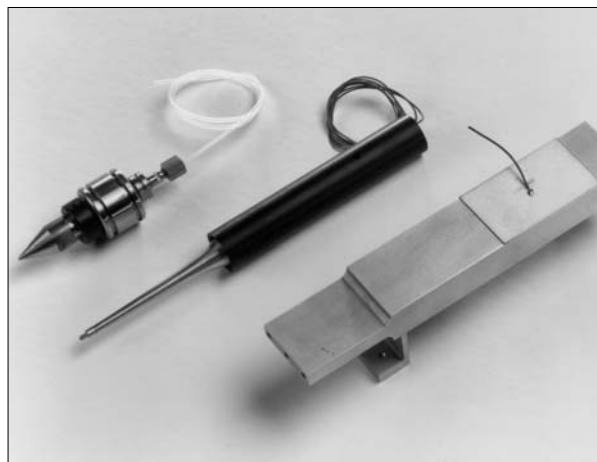

**ULTRASONICS**

### CONSULTING & ANALYSIS

Piezo Systems offers consultation on an hourly, daily, weekly, and monthly basis.

### PRODUCTION

Combined with proprietary processing techniques, Piezo Systems works closely with a network of highly specialized vendors. As a result Piezo Systems is capable of supplying highly sophisticated single parts or hundreds of thousands of parts per year.

**PIEZO LINEAR AMPLIFIER**  
**LOW ELECTRICAL NOISE - NO FAN**

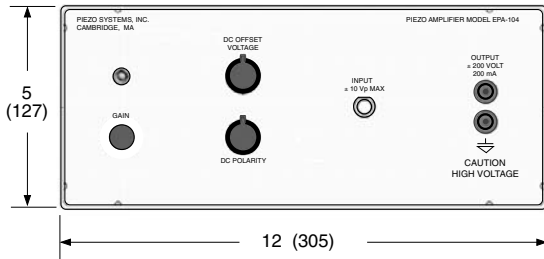

**SAMPLE SCOPE OUTPUTS**

Load: 0.1 µF Capacitor @ 1KHz  
 Channel 1: Input  
 Scale = 0.5 Vp / div  
 Time Base =250 µsec/ div  
 Channel 2: Output  
 Scale = 5 Vp / div  
 Time Base =250 µsec/ div

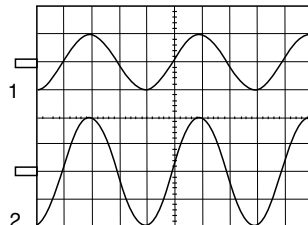

Load: 0.1 µF Capacitor @ 1KHz  
 Channel 1: Input  
 Scale = 5.0 Vp / div  
 Time Base =250 µsec/ div  
 Channel 2: Output  
 Scale = 50 Vp / div  
 Time Base =250 µsec/ div

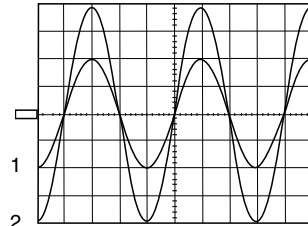

**ORDERING INFORMATION**

Piezo Linear Amplifier, ± 200 Vp/200mA (115VAC, 60Hz)  
 Piezo Linear Amplifier, ± 200 Vp/200mA (230VAC, 50Hz)  
 Insulated Banana Plugs, Red & Black

**PART NO.**

EPA-104-115  
 EPA-104-230  
 EPA-104-BPRB

**PRICE**

\$2,399  
 \$2,399  
 \$49

**DESCRIPTION**

Piezo Systems offers a general purpose, single channel, high voltage (± 200 Vp), high current (± 200 mA), and high frequency (DC to 300 KHz) amplifier designed to drive any load including piezo stacks, benders, and single sheets.

Low Electrical Noise, Low Distortion: The EPA-104 is made with a high quality Apex® High Voltage Hybrid Operational Amplifier, and utilizes low noise linear power supplies. It is housed in a heavy high conductivity aluminum case which provides an excellent shield from external electromagnetic interference.

Input and Output Protection: Piezo loads present special problems to electronic drivers. The EPA-104 provides heavy input and output protection to take care of all shorting, turn-on, turn-off, and load generated voltage occurrences which can damage either the amp or your actuator.

Manual Bias Controls (Polarity and DC offset): For making manual adjustments of drive voltage or for applying DC bias to dynamically driven piezo actuators such as piezo stacks.

Input (via analog signal to the BNC input connector): Accepts up to ± 10Vp signal waveforms from external signal generators, computer controllers, or feedback networks from DC to rated frequency. The combined AC plus DC offset voltage is adjustable from zero to the maximum rated voltage.

Gain Control: Convenient front panel adjustment of amplifier gain from 0 to 20X.

Output (via 4mm diameter safety sockets): High-voltage output terminals meet IEC1010 safety standard. Red and black insulated banana plugs with retractable sheath may be purchased separately. Wire connection to plugs is made with recessed screw.

**NOTE ON PIEZO LOADS**

To estimate the peak current requirement of a piezo actuator, solve the following equation:

$$I_p = 2 \pi F C V_p \quad (\text{in Amperes})$$

where F is the maximum operating frequency in Hertz, C is the capacitance of the piezo device in Farads, and Vp is maximum peak voltage required by the piezo actuator. The amplifier must be able to supply both Vp and Ip.



SPECIFICATIONS

EPA-104 PIEZO LINEAR AMPLIFIER

ELECTRICAL

Maximum Voltage	±200 volts peak
Maximum Current	±200 mA peak
Output Power	40.0 watts peak
Frequency Range	DC to 300 KHz
Full Power Bandwidth	
(Into 1 K   resistive load)	Flat (to within ±0.5 dB): DC to 250 KHz 3db roll-off: 400 KHz
(Into capacitive load)	See chart below
Voltage Gain	Variable gain, adjustable from 0 to 20X
Phase Shift	-.083° per KHz, typical
Slew Rate (No Load)	380 volts / µsec
Maximum Input Voltage	±10 volts peak
Maximum DC Component	±10 volts DC
Input Coupling	Direct DC coupling only
Input Impedance	10K ohm
Output Coupling	DC coupling
Variable DC Offset	Normally zero volts. Adjustable to ±200 volts peak
Load Impedance	Capable of driving any load within the voltage and current limitations of the amplifier.
Output Noise (300KHz bandwidth)	2 mV <sub>rms</sub> typical with input shorted
AC Power Source	User settable (fuse change required): 100 - 130 VAC, 50/60 Hz 200 - 250 VAC, 50/60 Hz
Circuit Protection	Overload, short circuit, and thermal protection

MECHANICAL

Front Panel Controls	Gain adjust; DC Polarity selector (+,0,-); DC Offset adjust
Rear Panel Controls	On/off switch; Line voltage selector
Terminals	BNC for input (ground referenced); Safety shrouded banana jacks for high voltage output terminals (ground referenced)
Weight	6.4 kg (14 lbs.)
Dimensions	305mm L x 305mm D x 127mm H (12" L x 12" D x 5" H)

ROHS

Compliant except for one component

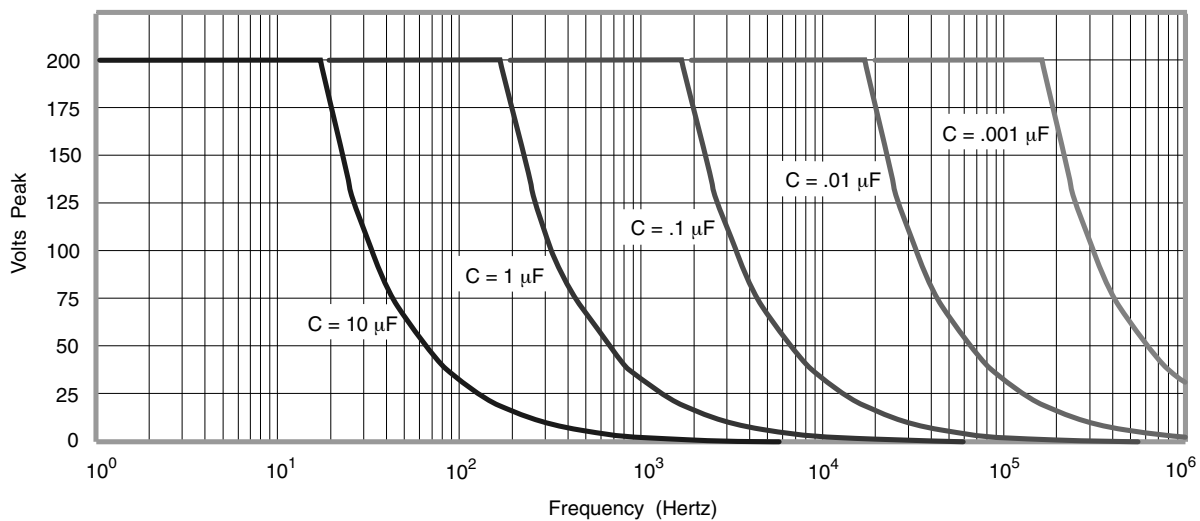

Peak Voltage Delivered to Capacitive Load at Peak Current Rating as a Function of Operating Frequency (Steady State Sinusoidal Waveforms; Temperature = 25 °C)

**LOW COST - PIEZO LINEAR AMPLIFIER**  
**±180Vp / ±30mA**



**DESCRIPTION**

The EPA-007-012 is a compact, high voltage, non-inverting, linear amplifier with an integral high voltage power supply. It is designed to be small in size and convenient for both bench top experimentation and OEM installation. It requires only a single 15VDC power input (provided), yet will accept +/- 10V ground referenced input and produce +/- 180V ground referenced output.

It is designed to be used as a high voltage drive source for various piezoelectric actuating devices and servo applications in the DC to 1500 Hz frequency range.

**FEATURES**

**Input Power:** For bench top experimentation, where minimum setup time and flexibility of amplifier location are real advantages, an AC adapter is provided for DC input power. A 115VAC/60Hz to 15VDC is included with the EPA-007-012. A 100-240VAC/50-60Hz (Universal Adapter) is included with the EPA-007-012B. For this model, one end of the power cord plugs into the adapter and the customer supplies the plug for the other end. For OEM or permanent installation, an auxiliary DC input is provided consisting of a set of screw terminals.

**Signal Input:** Input to the amplifier is made by connecting wires to the screw terminal connector on the I/O panel at one end of the unit. This is a ground referenced ±10V peak low voltage input.

**High Voltage Output:** Output from the amplifier appears at the two screw terminals on the I/O panel.

**Loads:** The EPA 007-012 is designed for driving piezo actuator loads.

**Input and Output Protection:** Piezo loads present special problems to electronic drivers. The EPA-007-012 provides input and output protection to take care of all shorting, turn-on, turn-off, and load generated voltage occurrences which can damage either the amp or your actuator.

**NOTE ON PIEZO LOADS**

To estimate the peak current (Ip) requirement of a piezo actuator, solve the appropriate equation:

Sine wave  $I_p = 2 \pi f C V_p$   
 Triangle wave  $I_p = 4 f C V_p$   
 Square wave  $I_p = C dV / dt$

Where Ip is the peak current in Amperes, f is the maximum operating frequency in Hertz, C is the capacitance of the piezo device in Farads, dt is the square wave rise time, and Vp is maximum peak drive voltage. The amplifier must be able to supply Vp, Ip and f simultaneously.

**DIMENSIONS**

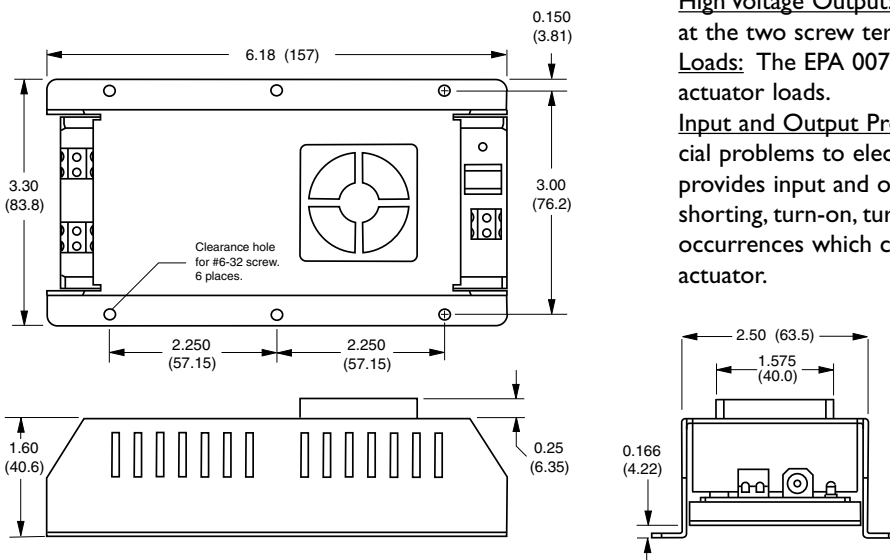

**ORDERING INFORMATION**

	PART NO.	1 pc.	5 pc.	25 pc.	100 pc.
Amplifier (with 115VAC/60Hz Input Adapter)	EPA-007-012	\$899	\$839	\$749	\$699
Amplifier (with Universal Input Adapter)	EPA-007-012B	\$949	\$889	\$789	\$734



SPECIFICATIONS

EPA-007-012 PIEZO LINEAR AMPLIFIER

ELECTRICAL

Amplifier Polarity	Non-inverting type, output in phase with input
Maximum Output Voltage	±180 volts peak
Maximum Output Current	±30 mA peak continuous
Output Power	5.4 watts peak
Open Circuit Frequency Response	Flat within ± 15% from 0 to 1,500 Hz
Voltage Gain	Fixed gain, 20X, ±5%
Maximum Input Voltage	±10 volts peak
Maximum DC Component	±10 volts DC
Input Coupling	DC coupled
Input Impedance	10K ohm
Output Coupling	DC coupled
Output Ripple	Typically <35 mV rms, with input shorted
Permissible Loads	Piezo, capacitive, resistive (not recommended for purely inductive loads)
Power Source	+13 VDC to + 18VDC, 750 mA
Current Draw	400 mA no load; 700 mA full load
Circuit Protection	Simple circuit limit, ~30 mA
Short Circuit Endurance	Indefinite
Cooling	Internal brushless DC fan
Isolation	Ground terminals for signal input, High voltage output, and 15VDC power input are electrically common.

MECHANICAL

Weight	256 g (0.56 lb)
Dimensions	157mm L x 84mm D x 46mm H

ROHS

ROHS Compliant

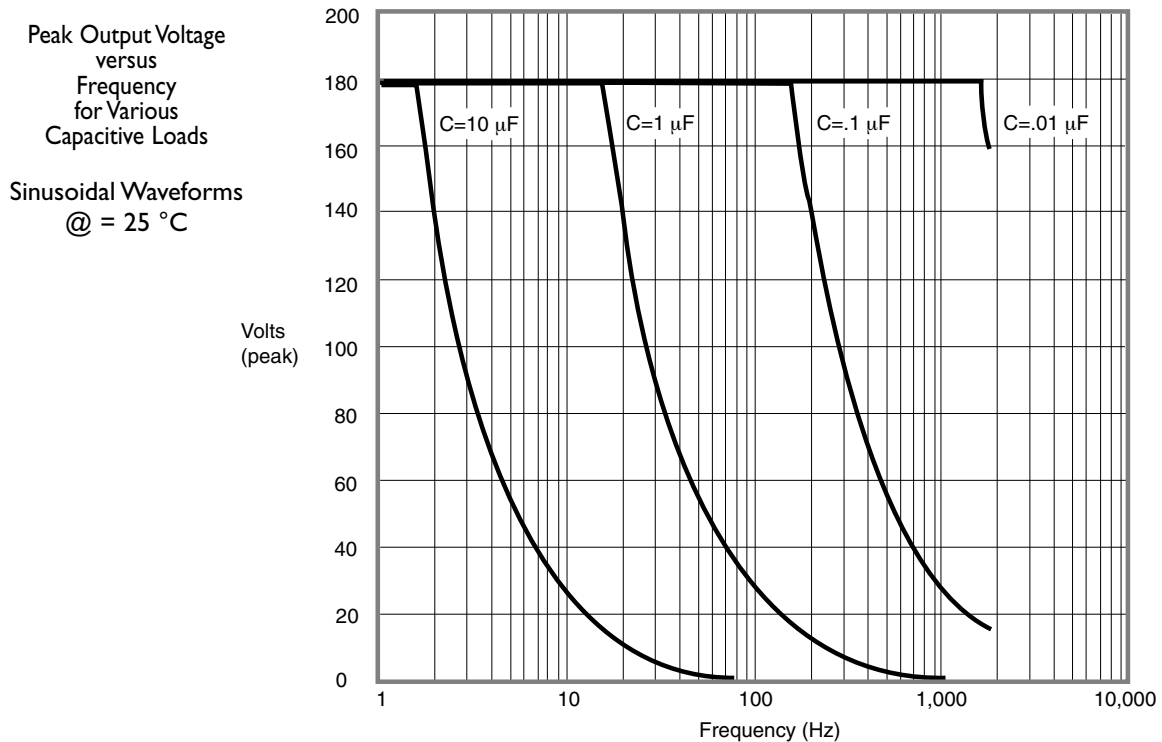

**PROPORTIONAL VOLTAGE BOOSTER**

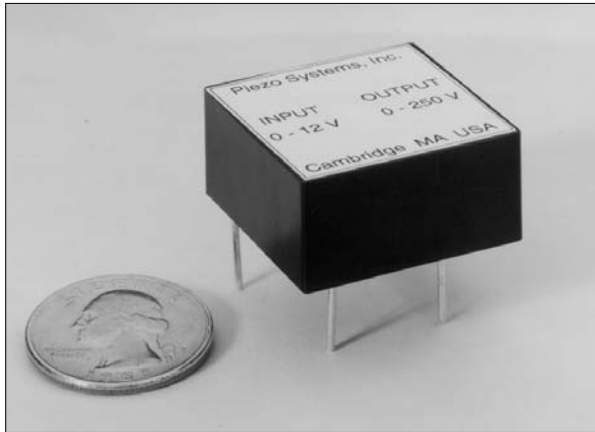

**DESCRIPTION**

The Proportional Voltage Booster provides a simple means of obtaining the high DC voltage used for driving piezo devices statically. It requires only a low voltage DC supply (or the output of an op-amp) on the input leg and a drain resistor on the output leg.

The Voltage Booster is small, PCB mountable, and well suited for low current / high voltage applications. Output voltage is proportional to input voltage, and is linear from ~ 10% to the maximum output voltage. Features include: low output ripple; floating output to enable the user to choose either positive or negative drive; short circuit protection; and, reverse polarity protection.

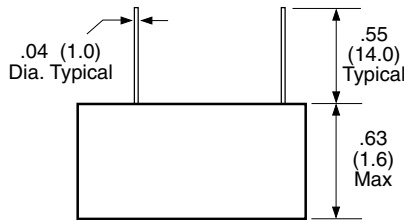
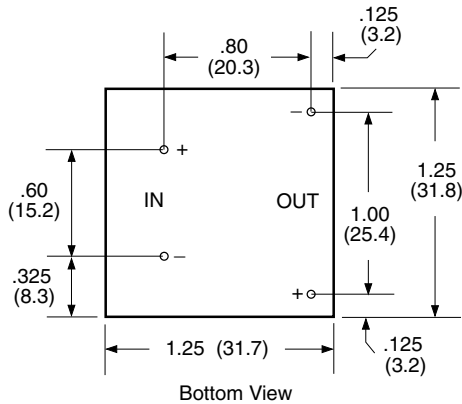

**BOOSTER SPECIFICATIONS**

Input Voltage:	0 - 12 VDC
Input Current:	85 mA Nominal
Output Voltage:	0 - 250 VDC Nominal
Output Current:	2 mA
Load Regulation:	5% (1/2 to full load)
Ripple:	< 0.5% p-p
Insulation Resistance:	3500 VDC
Weight:	42 grams
Temperature Range:	-20°C to +70°C

A 500 KΩ discharge resistor across the output terminals is recommended to sink charge when input voltage is removed.

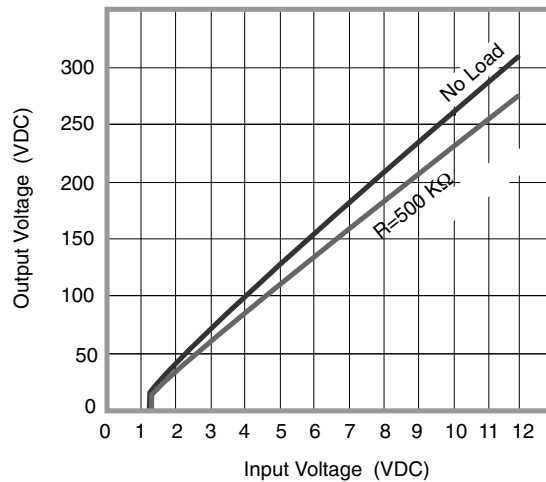
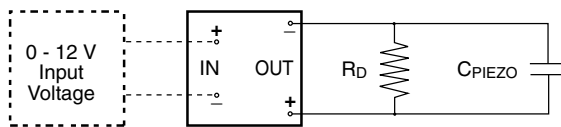

ORDERING INFORMATION	PART NO.	1 pc.	5 pc.	25 pc.	100 pc.
Proportional Voltage Booster	EVB-304	\$349	\$299	\$249	\$199



## DC TO AC INVERTER DRIVE CIRCUIT 0 TO ±15V<sub>peak</sub>, 50 - 150 Hz, Low Power Version

### DESCRIPTION

The Low Power Inverter Drive Circuit converts a DC input voltage (from 0 to +15VDC) to an AC output voltage (from 0 to ±15V<sub>peak</sub>) for driving low frequency (50 Hz - 150 Hz) piezo devices such as fans, choppers, vibrators, and benders **at resonance**.

Output frequency is manually adjusted by turning the trimmer pot on the PCB. Optimum tuning is accomplished by observing device amplitude or the output waveform on an oscilloscope during operation. Large input and output terminal pads are provided for clip leads during bench-top testing, and small pads are provided for permanent wiring. #2-56 clearance holes are provided for mounting the board on stand-offs.

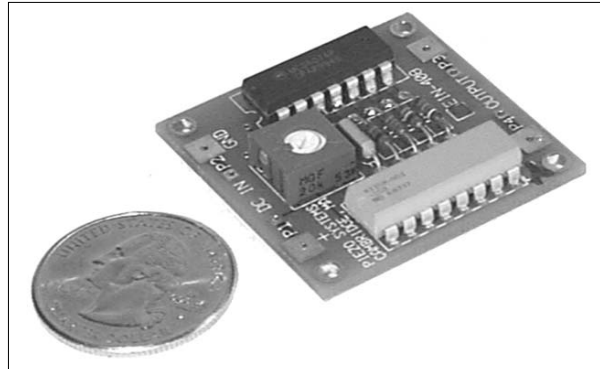

### INPUT / OUTPUT WAVEFORM

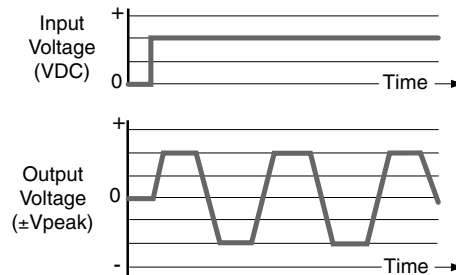

### DRIVING PIEZO RESONATORS

The Low Power Inverter Drive Circuit is primarily designed to drive the 12 -15VDC Low Power Piezo Fan Blade (see page 13) at resonance. However, it may also be used to drive piezo benders (see pages 27-51) and choppers (see page 11) up to ±15V<sub>p</sub> at resonance to achieve high deflections at low power.

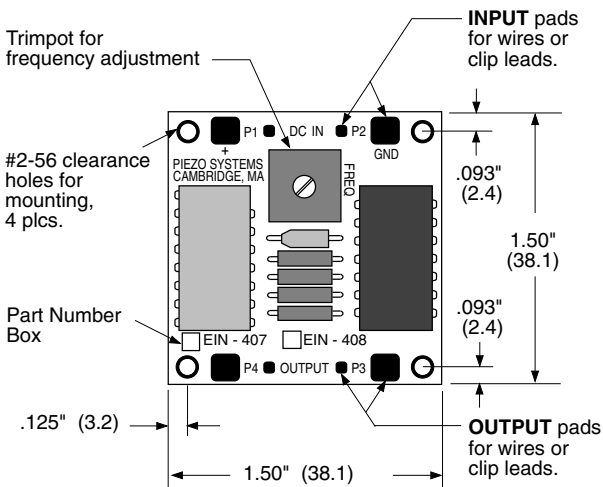
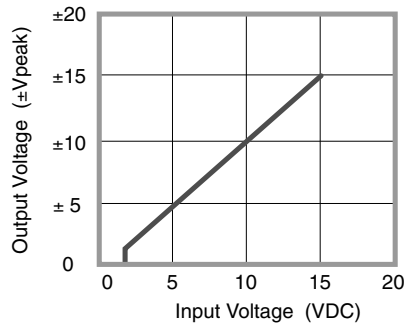

### INVERTER SPECIFICATIONS

Inverter Model		EIN-401
Input Voltage Range	+VDC	0 - 15
Output Voltage Range	V <sub>p</sub>	0 ± 15
Frequency Range (±10%)	Hz	50 - 150
Temperature Range	°C	0 -60
Weight	grams	8

ROHS

Compliant

### ORDERING INFORMATION

	PART NO.	1 pc.	5 pc.	25 pc.	100 pc.
Low Power Inverter Circuit (±15V <sub>p</sub> , 50 Hz - 150 Hz)	EIN-401	\$129	\$89	\$49	\$29

## DC TO AC INVERTER DRIVE CIRCUITS

### 0 TO ±44V<sub>peak</sub>, 50-150 Hz & 150-450 Hz VERSIONS

#### DESCRIPTION

The Inverter Drive Circuits convert DC input voltage (from 0 to +44VDC) to AC output voltage (from 0 to ±44 V<sub>peak</sub>) for driving low frequency (50 Hz - 450 Hz) piezo devices such as fans, choppers, vibrators, and benders at resonance.

Output frequency is manually adjusted by turning the trimmer pot on the PCB. Optimum tuning is accomplished by observing device amplitude or the output waveform on an oscilloscope during operation. Large input and output terminal pads are provided for clip leads during bench-top testing, and small pads are provided for permanent wiring. #2-56 clearance holes are provided for mounting the board on stand-offs.

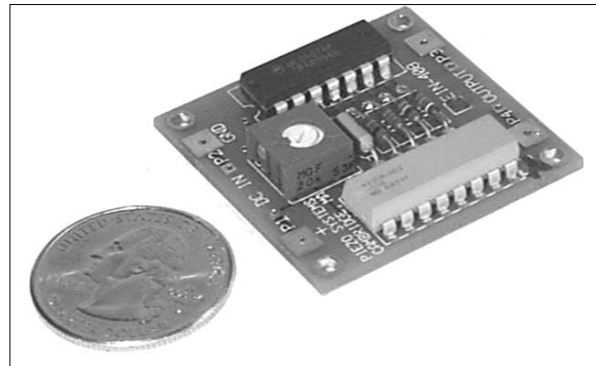

#### DRIVING PIEZO RESONATORS

**Resonant Piezo Chopper:** The 100 Hz piezo chopper (see page 11) may be driven using the EIN-407.

**Piezo Benders:** Bending elements (see pages 27-51) may be driven at resonance to achieve high deflection at low power. Depending on tip load, use the appropriate inverter circuit.

**Piezo Fans:** Piezo fans are driven at resonance. Depending on the design, resonant frequency is typically between 60 - 250 Hz. Use the appropriate inverter circuit (see pages 12-13).

#### INPUT / OUTPUT WAVEFORM

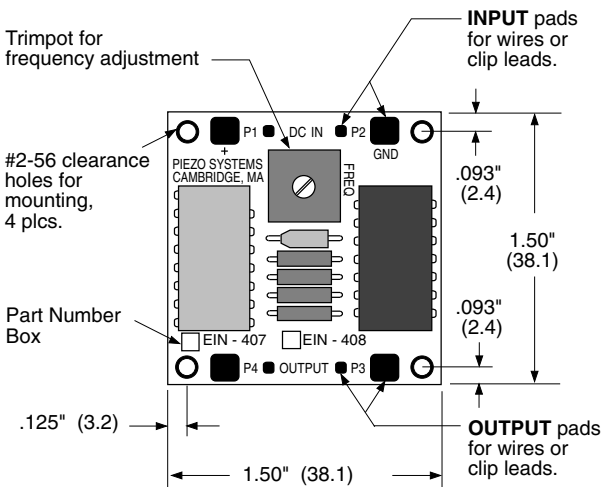
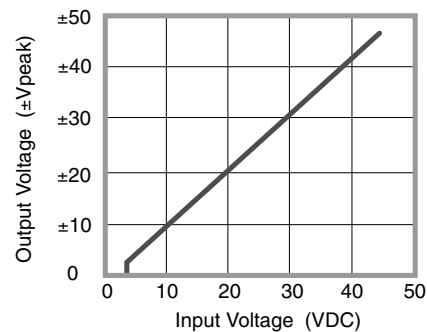
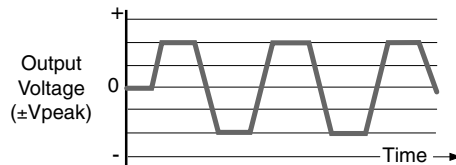
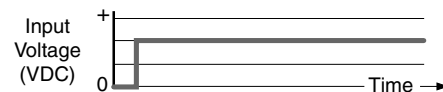

#### INVERTER SPECIFICATIONS

Inverter Model		EIN-407	EIN-408
Input Voltage Range	+VDC	0 - 44	0 - 44
Output Voltage Range	V <sub>p</sub>	0 ± 44	0 ± 44
Frequency Range (±10%)	Hz	50 - 150	155 - 450
Temperature Range	°C	0 - 60	0 - 60
Weight	grams	8	8

ROHS

Compliant Compliant

#### ORDERING INFORMATION

	PART NO.	1 pc.	5 pc.	25 pc.	100 pc.
Inverter Circuit (±44V <sub>p</sub> , 50 Hz - 150 Hz)	EIN-407	\$129	\$89	\$49	\$29
Inverter Circuit (±44V <sub>p</sub> , 150 Hz - 450 Hz)	EIN-408	\$129	\$89	\$49	\$29

**RESONANT PIEZOELECTRIC CHOPPER, 100 Hz VERSION**

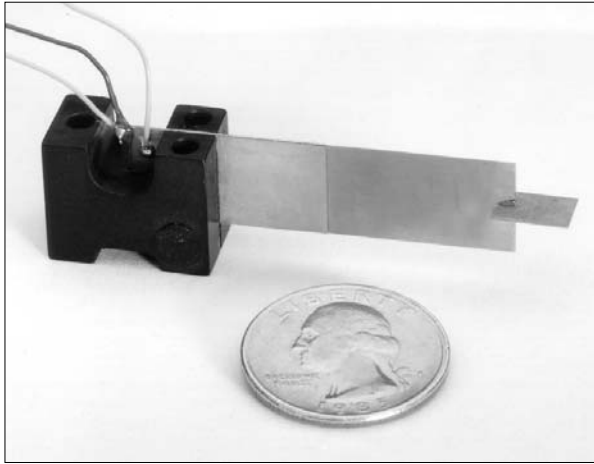

**SPECIFICATIONS**

Drive Voltage:	0 to $\pm 44$ V <sub>peak</sub>
Resonant Frequency ( $\pm 5\%$ ):	100 Hz
Shutter Displacement, $\pm \Delta X_p$	
Driven by Inverter @ $\pm 44$ Vp:	$\pm 6.8$ mm peak
Feedback Voltage**	
Driven by sinusoidal waveform @ 44 Vp:	13 Vp
Temperature Range:	0° to 60° C
Weight:	4.8 grams
Mounting Holes:	#2-56 inserts, tapped, 3 plcs.

\*\* If feed back voltage is desired, Inverter Drive Circuit can not be used to drive the chopper.

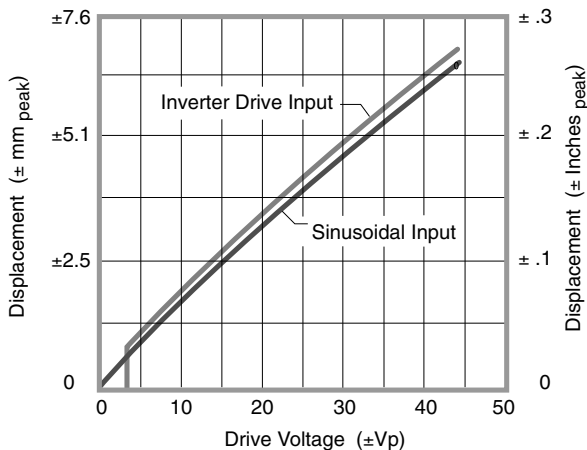

**CHOPPER DESCRIPTION**

The resonant piezoelectric chopper consists of a stainless steel shutter attached to the front tip of a resonating stainless steel blade. Piezoceramic on one side of the blade can be used for excitation while the piezoceramic on the other side can be used for drive circuit feedback.

The piezo chopper is small, lightweight, low power, reliable, and cost effective. It produces no heat, no EMI and operates over a wide temperature range.

“Off-the-shelf” delivery. Custom configurations (amplitudes, frequencies, sizes, thermal range, magnetic permeability, dual blade (i.e. tuning fork) available upon request.

**INVERTER DRIVE CIRCUIT**

The 100 Hz piezo chopper requires an oscillating drive signal matched to the resonant frequency of the chopper blade. This may be provided by a frequency generator/amplifier or inverter circuit. Piezo Systems provides an Inverter Drive Circuit (PN: EIN-407, see page 10) specifically designed to drive the 100 Hz chopper.

**CHOPPER EVALUATION KIT**

The Chopper Evaluation Kit includes a 100 Hz piezo chopper and a EIN-407 Inverter Drive Circuit.

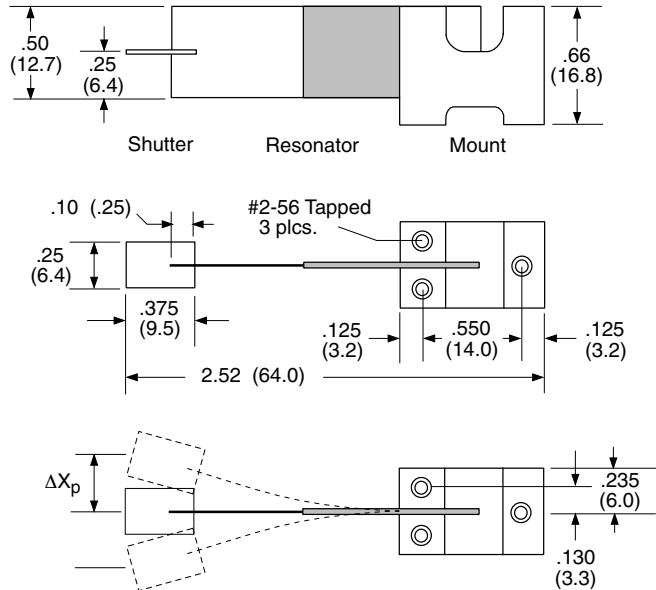

**ORDERING INFORMATION**

Piezo Chopper  
Piezo Chopper Evaluation Kit

PART NO.	1 pc.	5 pc.	25 pc.	100 pc.
RCHI-005	\$249	\$149	\$79	\$59
RCHIK-005	\$349			

**PIEZO FAN BLADE**  
115 V / 60 Hz VERSION

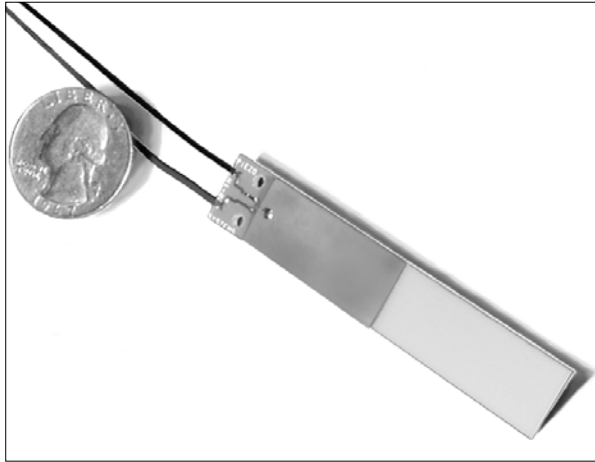

**DESCRIPTION OF PIEZO FAN**

Piezo fans are solid state devices without wearing parts. The oscillating mylar blade is driven at resonance by a piezo bending element. In free air, the high amplitude resonant vibration of the plastic blade causes the formation of a high velocity unidirectional flow stream. Maximum airflow occurs along the axes of the fan's centerline. Air intake is above and below the swept out volume of the blade. Its simple design lends itself to low cost in high volume production.

Piezo fans offer advantages over conventional fan technology. These include: instant starting with no power surge (especially desirable for spot cooling); ultralight weight; thin profile; extremely low magnetic permeability (suitable for use in high magnetic field environments such as NMR machinery and particle accelerators); and almost no heat dissipation (ideal for sealed enclosures). The 115 VAC / 60 Hz piezo fan can be driven directly off the power bus.

**Custom Piezo Fan Configurations:** Other piezo fans are available in custom configurations, including: different flow rates and sizes, high temperature operation (up to 150°C), low temperature operation, low vacuum operation, totally non-magnetic versions, DC operation, flow-through, and water-proof configurations.

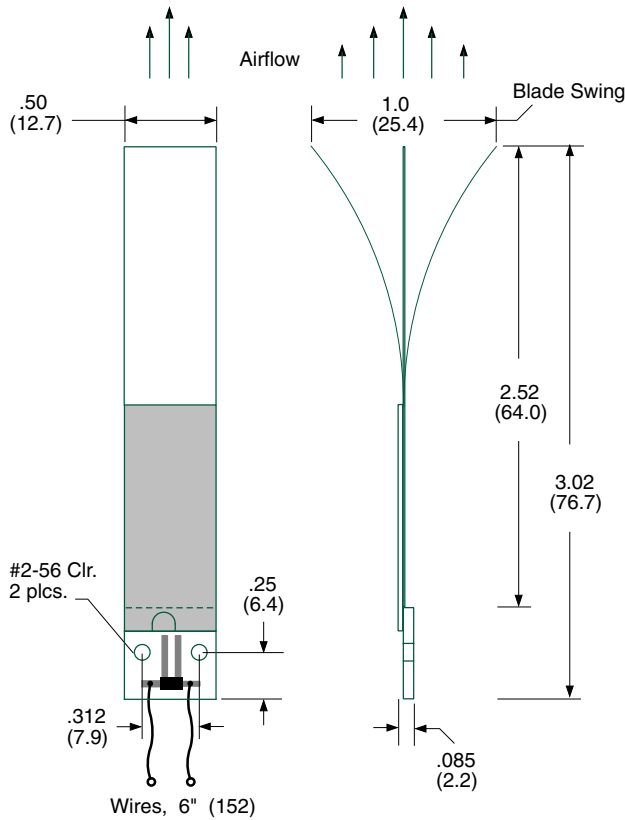

**FAN SPECIFICATIONS**

Input Voltage:	115 VAC, 60 Hz
Capacitance:	15 nF
Power Consumption:	30 mW
Volume Flow Rate:	2 CFM, (0.9 l/s)
Peak Air Velocity:	400 FPM, (2.0 m/s)
Weight:	2.8 grams
Mounting :	#2-56 clr. holes, 2 places
Temperature Range:	-20° C to 70° C
EMI / RFI:	None

**ROHS Compliant. Piezo exempt.**

**ORDERING INFORMATION**

Piezo Fan Blade, 115 V / 60 Hz

**PART NO.**

RFNI-005

**1 pc.**

\$149

**5 pc.**

\$89

**25 pc.**

\$59

**100 pc.**

\$49

**12 -15VDC / LOW POWER PIEZO FAN BLADE  
110 HZ VERSION**

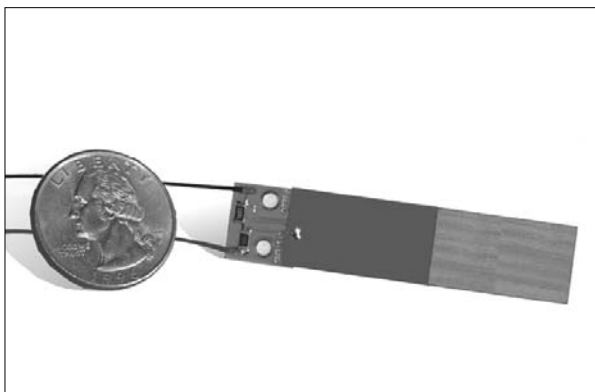

**DESCRIPTION OF LOW VOLTAGE FAN**

The low voltage / low power piezo fan is a solid state device designed to be used where low DC input voltage (12 - 15VDC) is available. The fan comprises a compound piezo/stainless steel blade mounted to a PCB mount incorporating a filter and bleed resistor. Oscillating blade motion creates a high velocity flow stream emanating from the leading edge of the blade. Air intake is above and below the swept out volume of the blade.

Piezo fans offer advantages over conventional fan technology. These include: instant start/stop with no power surge (especially desirable for spot cooling); ultralight weight; thin profile; no EMI; high reliability; operation over a wide temperature range; and essentially no heat dissipation (ideal for sealed enclosures), and low power consumption.

“Off-the-shelf” delivery. Custom configurations available upon request.

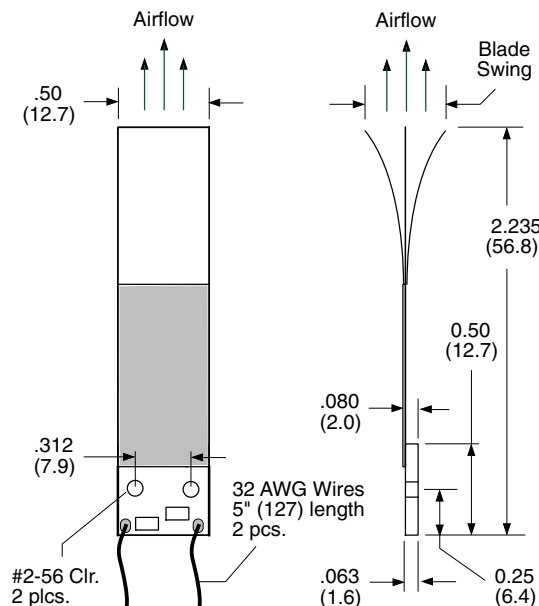

**INVERTER DRIVE CIRCUIT**

The piezo fan blade requires an oscillating drive signal matched to the resonant frequency of the blade. This may be provided by a frequency generator/amplifier or an inverter circuit. Piezo System's Inverter Drive Circuit (P/N EIN-409, see page 9) is used to drive the low power piezo fan blade.

**RESONANT BLADE EVALUATION KIT**

The Low Voltage / Low Power Piezo Fan Evaluation Kit includes one low voltage piezo fan and one EIN-401 Inverter Drive Circuit.

**PERFORMANCE (DRIVING FAN WITH EIN-401 INVERTER DRIVE CIRCUIT)**

	VDC	12VDC	15VDC
Input Voltage to EIN-409 Inverter Drive Circuit:	VDC	12VDC	15VDC
Current drawn by fan and circuit:	mA	2.2	2.8
Power Consumption of fan and circuit:	mW	26	42
Volume Flow Rate:	CFM (l/s)	0.5 (.24)	0.75 (.35)
Peak Air Velocity:	FPM (m/s)	275 (1.4)	435(2.2)
Resonant Frequency:	Hz	110	110
Blade Swing, peak to peak:	inches (mm)	0.31 (7.9)	0.375 (9.5)
Fan Capacitance	nF	90	90
Fan Weight	grams	2.0	2.0
Fan Temperature Range:	°C	-40° to 90°	-40° to 90°

**ROHS** Compliant. Piezo exempt.

**ORDERING INFORMATION**

	PART NO.	1 pc.	5 pc.	25 pc.	100 pc.
Low Voltage / Low Power Piezo Fan	RFNI-LV-02	\$149	\$89	\$59	\$49
Low Voltage / Low Power Piezo Fan Kit	RFNIK-LV-02	\$250			

**1-AXIS PIEZO MIRROR TILTERS, FROM ±0.4° TO ±1.0°**

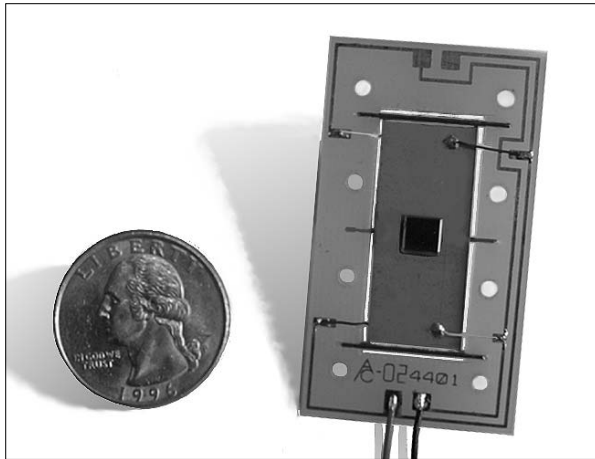

**DESCRIPTION**

The Piezo Mirror Tilters are low profile (~2.6 mm), light weight (~6 grams), high frequency devices designed for dynamic angular positioning at low power. These devices are capable of being directly bolted to gimbal mounts to replace bulky galvanometer systems. The piezoelectric motors deliver optical angles from ± 6 to ± 16 milliradians, while providing the fine resolution associated with piezoelectric devices. The tilter has very low magnetic permeability and produces no magnetic fields.

A 5mm square x 1mm thick crown glass mirror with a protected aluminium coating is attached to the tilter assembly (protected gold mirror option available). However, the customer may define or supply the optic to be attached.

The tilter may be mounted to mechanical ground using the eight 2 mm or #2-56 clearance holes located around the periphery of the printed circuit board.

The tilter requires an electrical driver capable of supplying up to the maximum rated voltage to deliver full range angular motion. Piezo System's EPA-104 Piezo Amplifier is suitable for driving the mirror tilters.

Custom configurations available upon request.

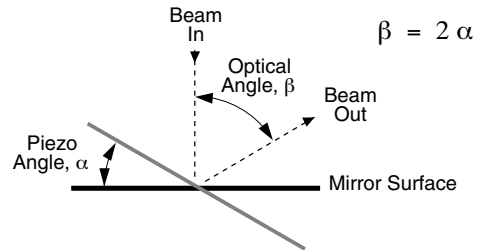
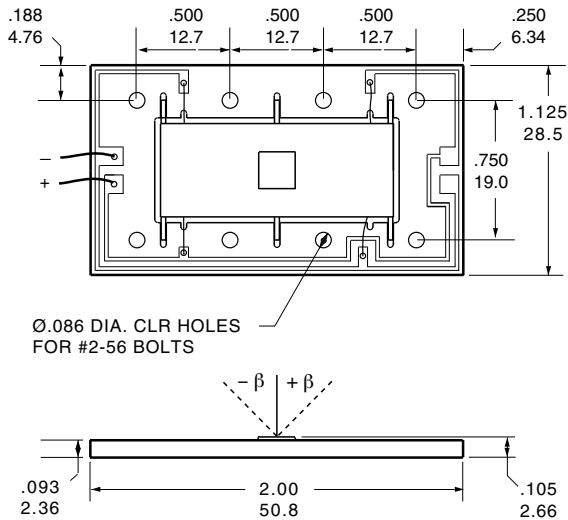

**SINGLE AXIS MIRROR TILTER PERFORMANCE**

PART NUMBER	WEIGHT	CAPACITANCE	RESONANT FREQUENCY	BROADBAND RANGE	RATED VOLTAGE	OPTICAL ANGLE, $\beta$		ANGULAR RESOLUTION
	grams	nF	Hz	Hz	±Vp	± milliradians	degrees	μradians
IAGI-A4CL-315H	5.6	23	2,250	0 - 1,000	± 120	± 16.5	± .95	3.3
IAGI-A4CL-319H	5.9	16	3,000	0 - 1,350	± 180	± 12.9	± .74	2.6
IAGI-A4CL-323H	6.0	16	3,800	0 - 1,700	± 180	± 9.7	± .55	1.9
IAGI-A4CL-323F	6.1	16	5,500	0 - 2,500	± 180	± 6.1	± .35	1.2

**ORDERING INFORMATION**

	PART NO.	1 pc.	5 pc.	25 pc.	100 pc.
1- Axis Mirror Tilter, ± .95°	IAGI-A4CL-315H	\$999	\$749	\$549	\$399
1- Axis Mirror Tilter, ± .74°	IAGI-A4CL-319H	\$999	\$749	\$549	\$399
1- Axis Mirror Tilter, ± .55°	IAGI-A4CL-323H	\$999	\$749	\$549	\$399
1- Axis Mirror Tilter, ± .35°	IAGI-A4CL-323F	\$999	\$749	\$549	\$399



**SPECIFICATIONS**

**1- AXIS PIEZO MIRROR FILTERS**

**MECHANICAL**

Overall Dimensions	
Length	50.8mm (2.00 inches)
Width	28.5mm (1.125 inches)
Height	2.66mm (0.105 inches)
Mounting	2.2mm (.086") diameter clearance holes for 2mm or #2-56 screws, 8 places.
Wires	2 wires, 32 AWG 305 mm (5 inches) long.
Mirror (Square, Flat)	
Material	Crown glass
Coating	Protected Aluminum
Reflectance range	100nm to 950nm
Mirror Dimensions	
Length	5.0mm (.197 inches)
Width	5.0mm (.197 inches)
Height	1.0mm (.039 inches)
Flatness	3 λ per 25 mm

**THERMAL**

Thermal Operating Range	-20 to 60° C
Thermal Storage Range	-30 to 70° C

**ROHS Compliant. Piezo exempt.**

Optical Angle versus DC Voltage

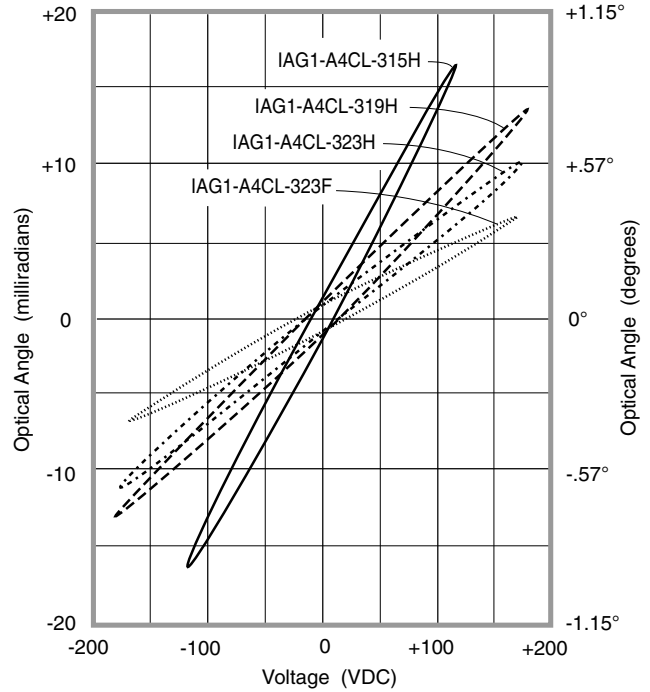

Optical Angle versus AC Voltage

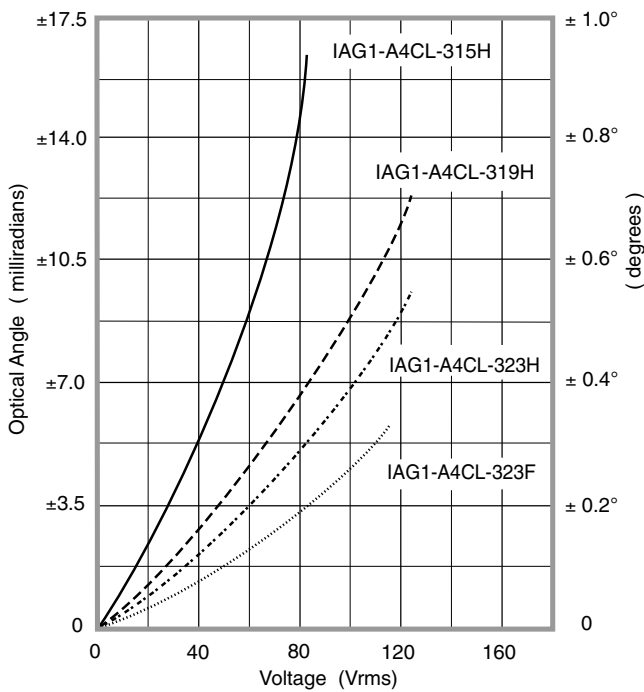

Optical Angle versus Frequency  
Drive voltage ~ 1/10 rated voltage

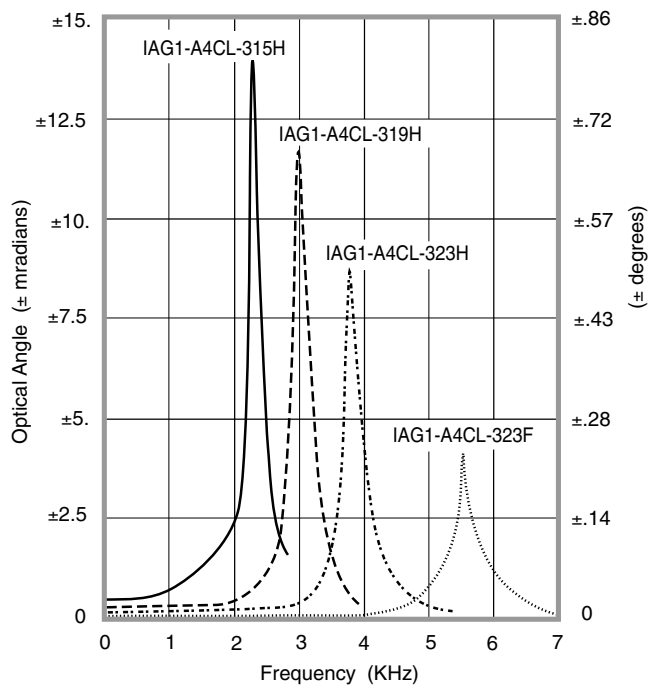



**2-AXIS PIEZO MIRROR TILTER, ± 1.6°  
ULTRA THIN PROFILE**

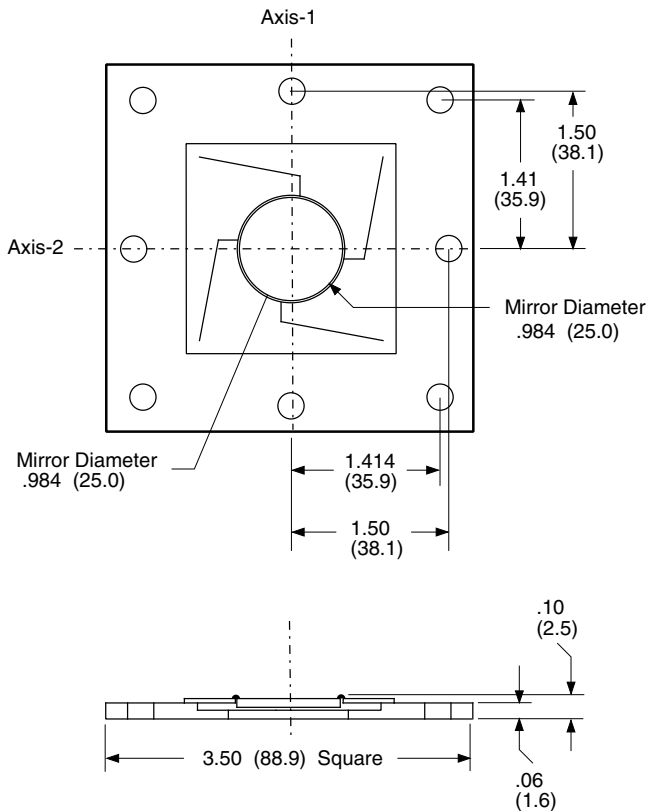
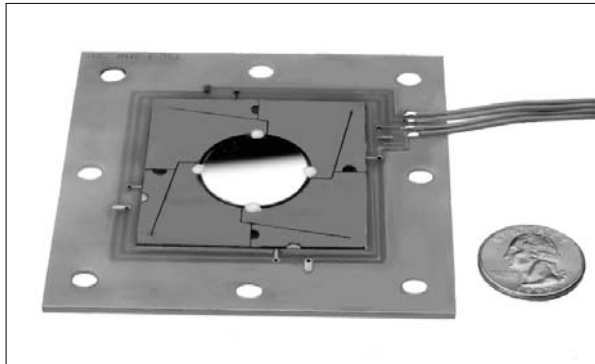

**DESCRIPTION**

The 2-Axis Piezo Mirror Tilter is a low profile device designed for insertion between closely spaced components in an optical path. It may be used for either reflective or refractive optical elements. The tilter delivers precise angular motions for dynamic beam steering, adjustment, or stabilization (with user provided feedback). The mirror tilter is best utilized when driven with continuous harmonic waveforms.

The tilter delivers ± 1.6° (± .028 radians) of optical angular motion while providing the fine resolution associated with piezoelectric devices. Mirror elements may be provided separately for individual custom applications.

Independent drive of each axis requires an electrical driver capable of supplying up to ± 180 volts peak (127Vrms) to deliver full range rotational output. Two EPA-104 Piezo Amplifiers are suitable for this purpose.

Mounting is accomplished using the #1/4 clearance holes on 3-inch centers for the English version. And using M6 clearance holes on 75 mm centers for the Metric version.

Custom Configurations: Piezo mirror tilters are available in custom configurations.

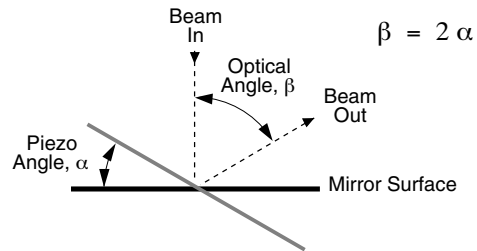

**DOUBLE AXIS MIRROR TILTER PERFORMANCE**

PART NUMBER	WEIGHT	CAPACITANCE (PER AXIS)	RESONANT FREQUENCY	BROADBAND RANGE	RATED VOLTAGE	OPTICAL ANGLE, $\beta$	ANGULAR RESOLUTION
	grams	nF	Hz	Hz	±Vp	± milliradians	degrees
IAG2-005-E	28	35	~325	0 - 150	± 180	± 28	± 1.6
							μradians
							6

**ORDERING INFORMATION**

PART NO.	1 pc.	5 pc.	25 pc.	100 pc.
2 - Axis Mirror Tilter, ± 1.6° English version IAG2-005-E	\$2,999	\$1,599	\$899	\$599
2 - Axis Mirror Tilter, ± 1.6° Metric version IAG2-005-M	\$2,999	\$1,599	\$899	\$599





**SPECIFICATIONS**

**2 - AXIS PIEZO MIRROR TILTER,  $\pm 1.6^\circ$**

**MECHANICAL**

Overall Dimensions (L x W x H)	inches (mm)	3.5 x 3.5 x .10 (89 x 89 x 2.5)
Overall Weight	grams	28
Mirror (Round, Flat)		
Dimensions (Dia. x T)	inches (mm)	$\varnothing$ .984 x .039 ( $\varnothing$ 25.0 x 1.0)
Material		Crown Glass
Coating		Protected Aluminum (100 nm - 950 nm)
Flatness		3 $\lambda$ per 25 mm
Mounting		#1/4-20 Clr holes, 8 places

**ELECTRICAL**

Rated Input Voltage (Vp)	Vp	$\pm 180$
Capacitance (per axis)	nF	35
Cable		4 conductor flat cable, unterminated 0.9 meters (36 inches) long

**ENVIRONMENTAL**

Thermal Operating Range	$^\circ$ C	-20 to +60
Thermal Storage Range	$^\circ$ C	-30 to +70

**PERFORMANCE**

Optical Angular Range (@ $\pm 180$ Vp)		$\pm 1.6$ degrees ( $\pm .028$ radians)
Resolution		$\pm .3 \times 10^{-3}$ degrees ( $\pm 6 \times 10^{-6}$ radians)
Broadband Operating Range	Hz	0 - 150
Resonant Frequency	Hz	$\sim 325$

**ROHS** Compliant. Piezo exempt.

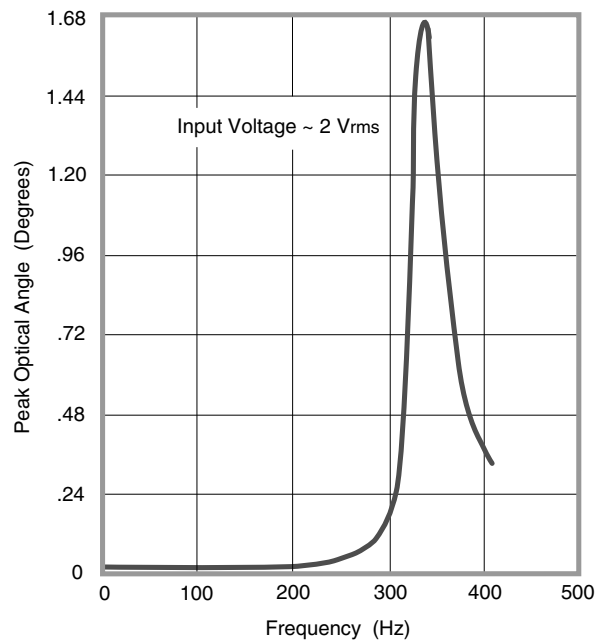
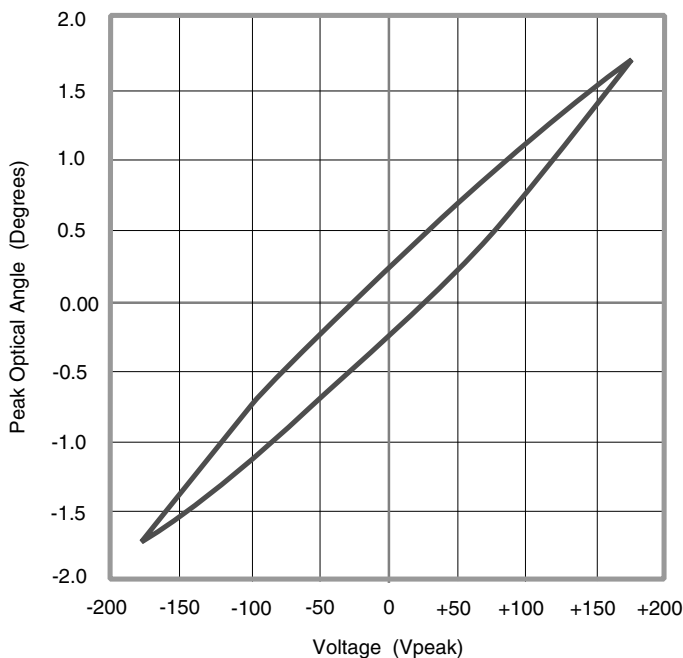

**PIEZOELECTRIC MOTOR/ACTUATOR KIT**

**DESCRIPTION**

The motor actuator kit is designed as a development tool for those who wish to quickly verify the feasibility of a piezoelectric approach to an idea or application. The piezoelectric materials provided in this kit represent some of the basic building blocks employed in constructing bending motors, extension motors, and stack motors. Emphasis is placed on designing and building bending actuators. Because the piezoelectric effect is reversible, the same elements are used as sensors and generators. PSI-5A4E piezoceramic was chosen for the kit because it offers the fewest voltage, temperature, and stress restrictions. It is, by far, the most commonly used piezoceramic in the industry.

The manual is intended to help the user model, fabricate, and test a prototype actuator as rapidly as possible. Quick and simple techniques for cutting piezoceramic elements to desired size are described, as well as attaching leads to the electrodes. Equations for free deflection, blocked force, resonant frequency, maximum stress, and capacitance allow the user to scale experimental results to many actuator designs.

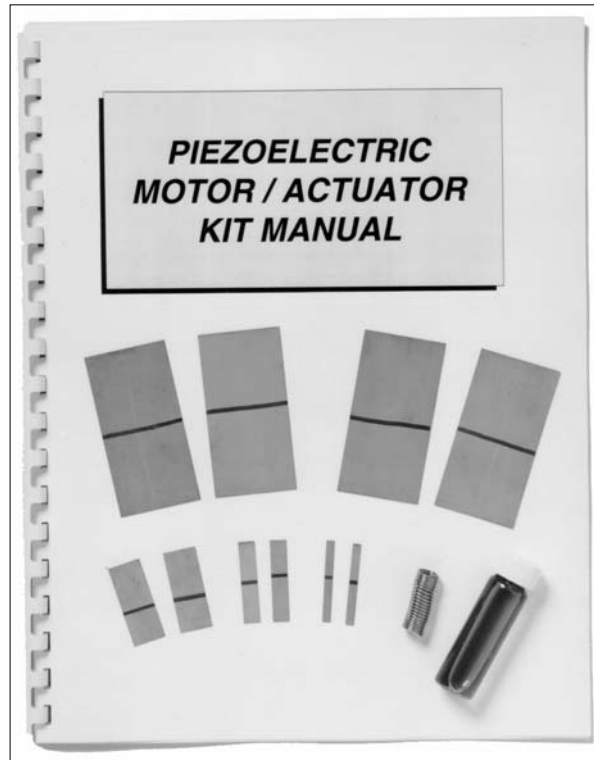

**PIEZO MOTOR APPLICATIONS**

- Micro actuators and manipulators for optical, robotic, fluidic, biomedical, electronic, and process engineering.
- Vibrating shutters and dithering devices.
- Acoustics and ultrasonics.
- Micro-pumps for process control and medical instrumentation.
- Small size, light weight, low power, solid state, actuators of all types for aerospace and battery powered devices.

**THE KIT INCLUDES**

- Piezoceramic Single Sheets; PSI-5A4E  
2 pieces: 1.25" x 2.5" x .0075"
- Standard 2-Layer Brass Shim Piezo Elements  
Poled for series operation  
1 piece: 2.50" x 1.250" x .020"  
1 piece: 1.25" x 0.500" x .020"  
1 piece: 1.25" x 0.250" x .020"  
1 piece: 1.25" x 0.125" x .020"  
Poled for parallel operation  
1 piece: 2.50" x 1.250" x .020"  
1 piece: 1.25" x 0.500" x .020"  
1 piece: 1.25" x 0.250" x .020"  
1 piece: 1.25" x 0.125" x .020"
- Piezoelectric Motor/Actuator Manual  
Introduction to Piezoelectricity  
Designing Piezoelectric Actuators  
Building Piezoelectric Actuators
- Wires, Solder and Flux
- **ROHS Compliant. Piezo exempt.**

ORDERING INFORMATION	PART NO.	PRICE
Piezoelectric Motor/Actuator Kit	KMA-005	\$499

## PIEZOELECTRIC GENERATOR/SENSOR KIT

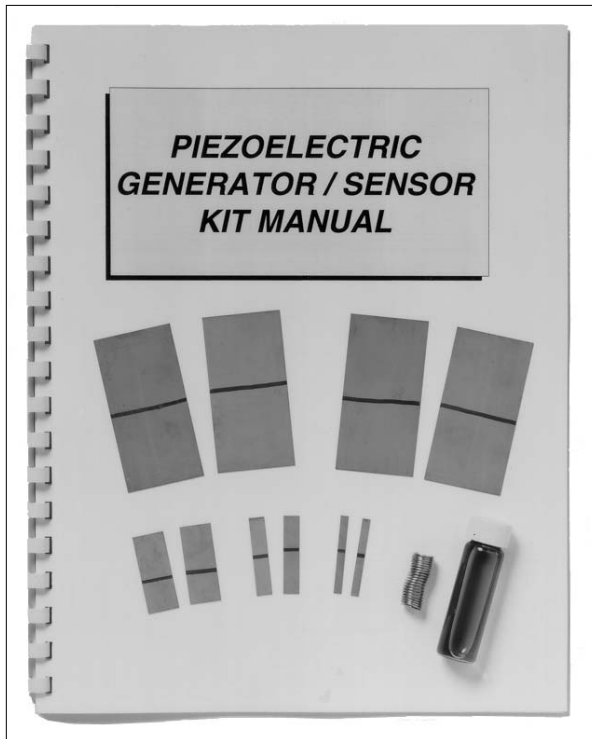

### DESCRIPTION

The generator / sensor kit is designed as a development tool for those who wish to quickly verify the feasibility of a piezoelectric approach to an idea or application. The piezoelectric materials provided in this kit represent some of the basic building blocks employed in constructing bending generators, extension generators, and stack generators. Because the piezoelectric effect is reversible, the same elements are used as motors and actuators. PSI-5A4E piezoceramic was chosen for the kit because it offers the fewest voltage, temperature, and stress restrictions. It is, by far, the most commonly used piezoceramic in the industry.

The manual is intended to help the user model, fabricate, and test a prototype generator as rapidly as possible. For example, quick and simple techniques for cutting ceramic elements to desired size are described. Equations for open circuit voltage, closed circuit current, resonant frequency, maximum stress, and capacitance allow the user to scale experimental results to many actuator designs.

### THE KIT INCLUDES

- Piezoceramic Single Sheets; PSI-5A4E  
2 pieces: 1.25" x 2.5" x .0075"
- Standard 2-Layer Brass Shim Piezo Elements  
Poled for series operation
  - 1 piece: 2.50" x 1.250" x .020"
  - 1 piece: 1.25" x 0.500" x .020"
  - 1 piece: 1.25" x 0.250" x .020"
  - 1 piece: 1.25" x 0.125" x .020"
 Poled for parallel operation
  - 1 piece: 2.50" x 1.250" x .020"
  - 1 piece: 1.25" x 0.500" x .020"
  - 1 piece: 1.25" x 0.250" x .020"
  - 1 piece: 1.25" x 0.125" x .020"
- Piezoelectric Generator / Sensor Manual  
Introduction to Piezoelectricity  
Designing Piezoelectric Generators  
Building Piezoelectric Generators
- Wires, Solder and Flux
- **ROHS Compliant. Piezo exempt.**

### PIEZO GENERATOR APPLICATIONS

- Self energized accelerometers
- Activity & rate response sensors
- Vibration control & damping
- Dynamic strain instrumentation
- Small size, light weight, self-power, solid state sensors

### ORDERING INFORMATION

Piezoelectric Generator/Sensor Kit

### PART NO.

KGS-006

### PRICE

\$499

### INTRODUCTION TO PIEZO TRANSDUCERS

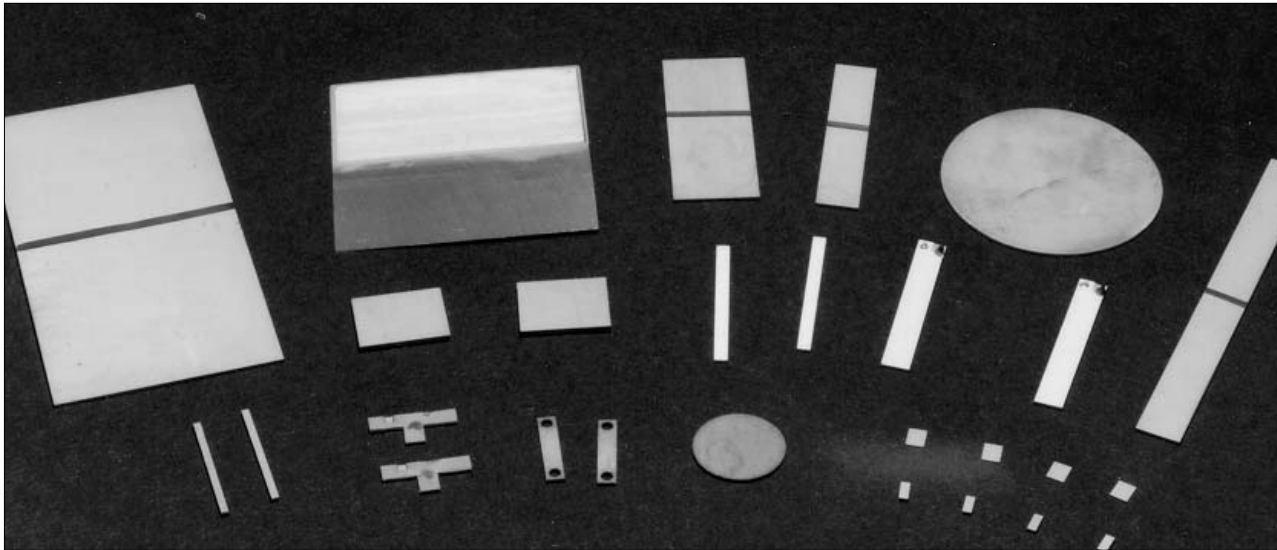

#### PIEZO TRANSDUCERS

Transducers convert one form of energy to another. Piezo **motors** convert electrical energy to mechanical energy, and piezo **generators** convert mechanical energy to electrical energy. In most cases the same element can be used to perform either task.

Piezo Systems offers large **single sheets** in standard thicknesses of .005", .0075", .0105", .020", .040", and .080". These sheets, described on [pages 24-26](#), can be energized to produce motion in the thickness, length, and width directions, or stretched and compressed to generate electrical output.

Thin **2-layer elements** are perhaps the most versatile configuration of all. They may be used like single sheets (made up of 2 layers), or they can be used to bend. "Benders" achieve large deflections relative to other piezo transducers. They are available in a range of standard thicknesses. [Pages 27-52](#) present information pertaining to their use as motors and generators.

Multilayered piezo **stacks**, discussed

on [pages 54-55](#), are capable of delivering and supporting high force loads with minimal compliance, but deliver small motions.

In addition to the standard transducers presented in this section, Piezo Systems provides custom configurations tailored to user specifications.

#### PIEZO MOTORS (ACTUATORS)

Piezo motors convert voltage and charge to force and motion.

##### SINGLE LAYER MOTORS

**LONGITUDINAL AND TRANSVERSE MOTORS:** When an electric field having the same polarity and orientation as the original polarization field (see Introduction to Piezoelectricity, [pages 57-61](#)) is placed across the thickness

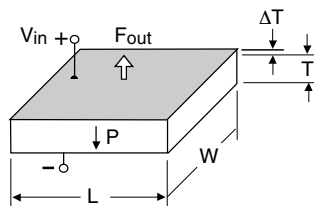

Fig.-1. Longitudinal (d33) Motor

of a single sheet of piezoceramic, the piece expands in the thickness or "longitudinal" direction (i.e. along the axis of polarization) and contracts in the transverse direction (perpendicular to the axis of polarization). This is represented in [Figures-1](#) and [2](#). When the field is reversed, the motions are reversed. Sheets and plates utilize this effect. However, the motion of a sheet in the thickness direction is extremely small (on the order of tens of nanometers). On the other hand, the transverse motion along the length is generally larger (on the order of microns to tens of microns) since the length dimension is often substantially greater than the thickness. The transverse motion of a sheet laminated to the surface of a structure can induce the structure to stretch or bend, a feature often exploited in structural control systems.

##### 2-LAYER MOTORS

Two-layer elements can be made to elongate, bend, or twist depending on the polarization and wiring configuration of the layers.

A center shim laminated between the

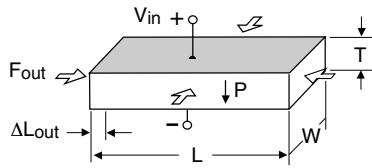

Figure-2. Transverse (d31) Motor, Contracting.

two piezo layers adds mechanical strength and stiffness, but reduces motion.

“2-layer” refers to the number of piezo layers. The “2-layer” element actually has nine layers, consisting of: four electrode layers, two piezoceramic layers, two adhesive layers, and a center shim.

The two layers offer the opportunity to reduce drive voltage by half when configured for parallel operation.

**EXTENSION MOTORS:** A 2-layer element behaves like a single layer when both layers expand (or contract) together. If an electric field is applied which makes the element thinner, extension along the length and width results. Typically, only motion along one axis is utilized (see Figure-3). Extender motion on the order of microns to tens of microns, and force from tens to hundreds of Newtons is typical.

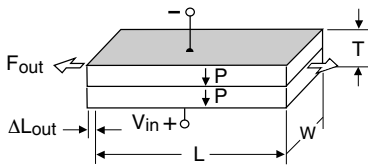

**For extension motors of the same thickness:**

- Xf, Free Deflection  $\propto L$
- Fb, Blocked Force  $\propto W$
- Fr, Resonant Frequency  $\propto 1/L$
- C, Capacitance  $\propto L \times W$

Figure-3. 2-Layer Transverse Motor Expanding lengthwise

**BENDING MOTORS:** A 2-layer element produces curvature when one layer expands while the other layer contracts. These transducers are often referred to as benders, bimorphs, or flexural elements. Bender motion on the order of hundreds to thousands of microns, and bender force from tens to hundreds of grams, is typical.

Figures 4a, 4b and 4c show several common bending configurations. The variety of mounting and motion options make benders a popular choice of design engineers.

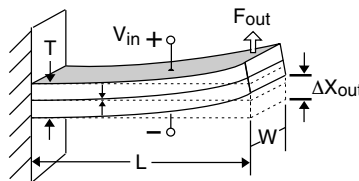

**For cantilevered benders of the same thickness:**

- Xf, Free Deflection  $\propto L^2$
- Fb, Blocked Force  $\propto W/L$
- Fr, Resonant Frequency  $\propto 1/L^2$
- C, Capacitance  $\propto L \times W$
- Characteristics: End takes on an angle. Simple to mount.

Figure-4a. 2-Layer Bending Motor Cantilever Mount

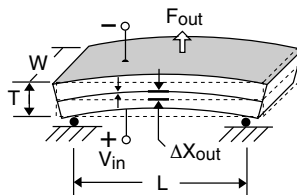

**To convert cantilever to simple beam performance:**

- Xf = 1/4X cantilever motion
- Fb = 4X cantilever force
- Fr  $\approx$  3X cantilever frequency
- C = same as cantilever capacitance
- Characteristics: Center moves up and down in a parallel plane.

Figure-4b. 2-Layer Bending Motor Simple Beam Mount

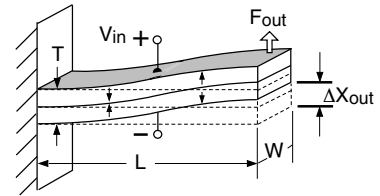

**To convert cantilever to “S” beam performance:**

- Xf = 1/2 x cantilever motion
- Fb = 1/2 x cantilever force
- Fr  $\approx$  same as cantilever frequency
- C = same as cantilever capacitance
- Characteristics: End moves up and down in a parallel plane.

Figure-4c. 2-Layer Bending Motor “S” Configuration, Cantilever Mount

**MULTI-LAYER MOTORS**

Any number of piezo layers may be stacked on top of one another. Increasing the volume of piezoceramic increases the energy that may be delivered to a load. As the number of layers grows, so does the difficulty of accessing and wiring all the layers. Typically, more than four layers becomes impractical.

**STACK MOTORS:** The co-fired stack represented in Figure-5 is a practical way to assemble and wire a large number of piezo layers into one monolithic structure. The tiny motions of each layer contribute to the overall displacement. Stack motion on the order of microns to tens of microns, and force from hundreds to thousands of Newtons is typical.

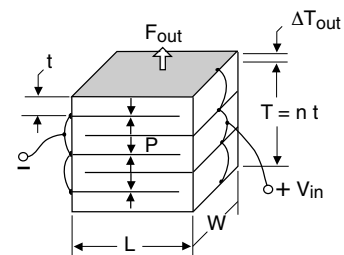

Figure-5. Stack Motor

### MOTOR PERFORMANCE

Piezoelectric actuators are usually specified in terms of their free deflection and blocked force. Free deflection ( $X_f$ ) refers to displacement attained at the maximum recommended voltage level when the actuator is completely free to move and is not asked to exert any force. Blocked force ( $F_b$ ) refers to the force exerted at the maximum recommended voltage level when the actuator is totally blocked and not allowed to move. Deflection is at a maximum when the force is zero, and force is at a maximum when the deflection is zero. All other values of simultaneous displacement and force are determined by a line drawn between these points on a force versus deflection line, as shown in Figure-6. Generally, a piezo motor must move a specified amount and exert a specified force, which determines its operating point on the force vs. deflection line. An actuator is considered optimized for a particular application if it delivers the required force at one half its free deflection. All other actuators satisfying the design criteria will be larger, heavier, and consume more power.

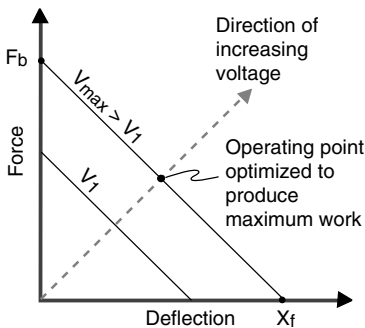

Figure-6. Force vs. displacement diagram for a piezo motor.

### PIEZO GENERATORS (SENSORS)

Piezo generators convert force and motion to voltage and charge.

#### SINGLE LAYER GENERATORS

**LONGITUDINAL AND TRANSVERSE GENERATORS:** When a mechanical stress is applied to a single sheet of piezoceramic in the longitudinal direction (parallel to polarization), a voltage is generated which tries to return the piece to its original thickness (Figure-7). Similarly, when a stress is applied to a sheet in a transverse direction (perpendicular to polarization), a voltage is generated which tries to return the piece to its original length and width (Figure-8). A piezo sheet bonded to a structural member which is stretched or flexed will induce electrical generation.

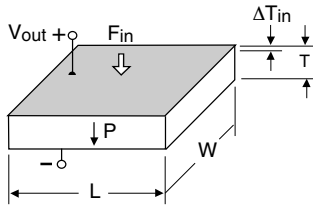

Fig-7. Longitudinal (d33) Generator

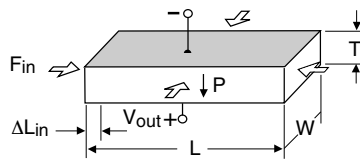
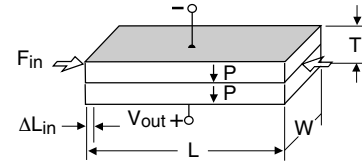

Fig-8. Transverse (d31) Generator, Compressed on sides.

#### 2-LAYER GENERATORS

Applying a mechanical stress to a laminated two layer element results in electrical generation depending on the direction of the force, the direction of polarization, and the wiring of the individual layers.

**EXTENSION GENERATORS:** When a mechanical stress causes both layers of a suitably polarized 2-layer element to stretch (or compress), a voltage is generated which tries to return the piece to its original dimension. Essentially, the element acts like a single sheet of piezo. The metal shim sandwiched between the two piezo layers provides mechanical strength and stiffness while shunting a small portion of the force (Figure-9).



**For extension generators of the same thickness and force loading:**

$$X_L, \text{ Deflection Limit} \propto L$$

$$V_{oc}, \text{ Open Circuit Voltage} \propto X_L / L = I$$

$$I_{cc}, \text{ Closed Circuit Current} \propto L \times W$$

Fig-9. 2-Layer Transverse Generator, Compressed lengthwise.

**BENDING GENERATORS:** When a mechanical force causes a suitably polarized 2-layer element to bend, one layer is compressed and the other is stretched. Charge develops across each layer in an effort to counteract the imposed strains. This charge may be collected as observed in Figure-10a and 10b

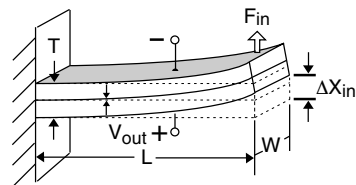

**For bending generators of the same thickness and force loading:**

$$X_L, \text{ Deflection Limit} \propto L^2$$

$$V_{oc}, \text{ Open Circuit Voltage} \propto X_L / L^2 = I$$

$$I_{cc}, \text{ Closed Circuit Current} \propto L \times W$$

Figure-10a. Bending Generator, Cantilever Mount



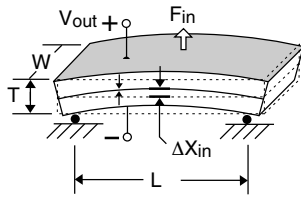

To convert cantilever to simple beam generator performance (for the same thickness and force load):

$V_{oc} = 1/4X$  cantilever voltage  
 $I_{cc} = 1/4X$  cantilever current

To convert cantilever to simple beam performance (for the same thickness and deflection):

$V_{oc} = 4X$  cantilever voltage  
 $I_{cc} = 4X$  cantilever current

Figure-10b. Bending Generator, Simple Beam Mount

**MULTI-LAYER GENERATORS**

**STACK GENERATORS:** The stack, which comprises a large number of piezo layers, is a very stiff structure with a high capacitance. It is suitable for handling high force and collecting a large volume of charge.

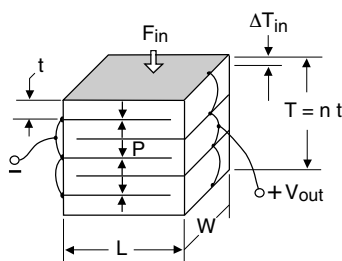

Figure-11. Stack Generator

**GENERATOR PERFORMANCE**

For sinusoidal drive, piezoelectric generators may be specified in terms of their closed-circuit current and open-circuit voltage. Closed-circuit current,  $I_{CC}$ , refers to the total current developed, at the maximum recommended strain level and operating frequency, when charge is completely free to travel from one electrode to the other, and is not asked to build up

voltage. Open-circuit voltage,  $V_{oc}$ , refers to the voltage developed at the maximum recommended strain level, when charge is prohibited from traveling from one electrode to the other. Current is at a maximum when the voltage is zero, and voltage is at a maximum when the charge transfer is zero. All other values of simultaneous current and voltage levels are determined by a line drawn between these points on a voltage versus current line, as shown in Figure-12. Generally, a piezo generator must deliver a specified current and voltage, which determines its operating point on the voltage vs. current line. Maximum power extraction for a particular application occurs when the generator delivers the required voltage at one half its closed circuit current. All other generators satisfying the design criteria will be larger, heavier, and require more power input.

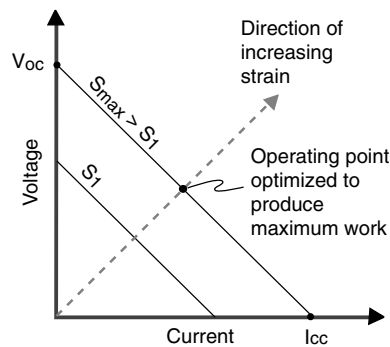

Figure-12. Voltage vs. current diagram for a piezo generator.

**STATIC & DYNAMIC OPERATION**

As a sensor or force gauge, piezo elements are excellent for handling dynamic and transient inputs, but poor at measuring static inputs. This is due to charge leakage between electrodes and into monitoring circuits.

Piezoceramic may be used as a strain gauge for easy and rapid determina-

tion of dynamic strains in structures. They exhibit extremely high signal/noise ratios, on the order of 50 times that of wire strain gauges, and are small enough that on most structures they will not materially affect the vibrational characteristics of the structure.

**SERIES & PARALLEL OPERATION**

For motors, series operation refers to the case where supply voltage is applied across all piezo layers at once. The voltage on any individual layer is the supply voltage divided by the total number of layers. A 2-layer device wired for series operation uses only two wires (Figure-13), one attached to each outside electrode.

Parallel operation refers to the case where the supply voltage is applied to each piezo layer individually. This means accessing and attaching wires to each layer. A 2-layer bending motor wired for parallel operation requires three wires (Figure-14), one attached to each outside electrode and one attached to the center shim. For the same motion, a 2-layer motor poled for parallel operation needs only half the voltage required for series operation and has four times the capacitance.

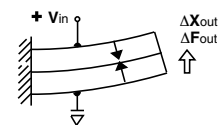

Figure-13. A 2-Layer Bending Motor Poled for Series Operation (2-wire)

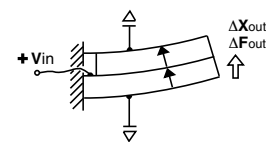
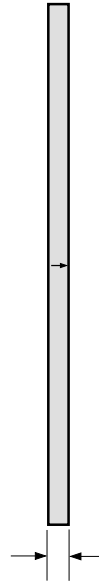
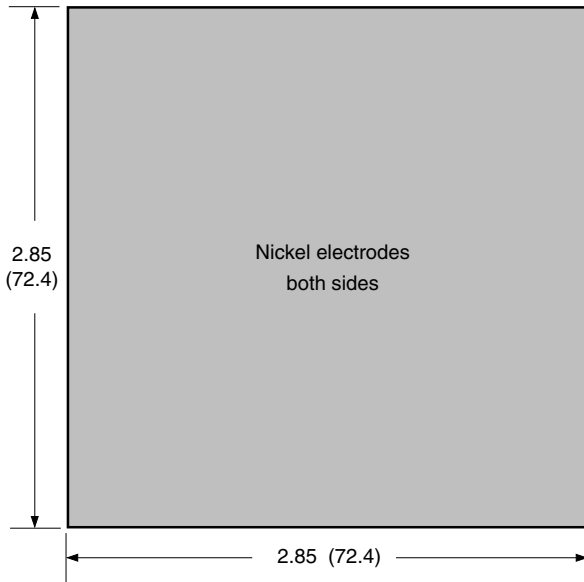

Figure-14. A 2-Layer Bending Motor Poled for Parallel Operation (3-wire)

### PSI-5A4E PIEZOELECTRIC SINGLE SHEETS



PART NUMBER	THICKNESS	CAPACITANCE
	mm	nF (±10%)
T105-A4E-602	.127	650
T107-A4E-602	.191	430
T110-A4E-602	.267	315
T120-A4E-602	.508	162
T140-A4E-602	1.02	80
T180-A4E-602	2.03	40

.005 ± .0005	(.127 ± .013)
.0075 ± .0005	(.191 ± .013)
.0105 ± .0005	(.267 ± .013)
.020 ± .0005	(.508 ± .013)
.040 ± .0010	(1.016 ± .025)
.080 ± .0020	(2.032 ± .050)

#### PIEZOELECTRIC & MATERIAL PROPERTIES OF PSI-5A4E SINGLE SHEETS

##### PIEZOELECTRIC

Composition	Lead Zirconate Titanate	
Piezo Systems Material Designation	Type 5A4E (Industry Type 5A, Navy Type II)	
Relative Dielectric Constant (@1KHz)	$K^T_3$	1800
Piezoelectric Strain Coefficient	$d_{33}$	$390 \times 10^{-12}$ meter/Volt
	$d_{31}$	$-190 \times 10^{-12}$ meter/Volt
Piezoelectric Voltage Coefficient	$g_{33}$	$24.0 \times 10^{-3}$ Volt meter/Newton
	$g_{31}$	$-11.6 \times 10^{-3}$ Volt meter/Newton
Coupling Coefficient	$k_{33}$	0.72
	$k_{31}$	0.35
Polarization Field	$E_p$	$2 \times 10^6$ Volt/meter
Initial Depolarization Field	$E_c$	$5 \times 10^5$ Volt/meter

##### MECHANICAL

Density	$\rho$	7800	Kg/meter <sup>3</sup>
Mechanical Q		80	
Elastic Modulus	$Y^E_3$	$5.2 \times 10^{10}$	Newton/meter <sup>2</sup>
	$Y^E_1$	$6.6 \times 10^{10}$	Newton/meter <sup>2</sup>

##### THERMAL

Thermal Expansion Coefficient		$\sim 4 \times 10^{-6}$	meter/meter °C
Curie Temperature		350	°C

**ROHS** Compliant. Piezoceramic exempted from requirements of Article 4(I).

#### ORDERING INFORMATION

	PART NO.	1 pc.	5 pc.	25 pc.	100 pc.
PSI-5A4E (2.85" Square x .005"T)	T105-A4E-602	\$100	\$70	\$50	\$35
PSI-5A4E (2.85" Square x .0075"T)	T107-A4E-602	\$100	\$60	\$40	\$30
PSI-5A4E (2.85" Square x .0105"T)	T110-A4E-602	\$100	\$70	\$50	\$35
PSI-5A4E (2.85" Square x .020"T)	T120-A4E-602	\$125	\$90	\$70	\$60
PSI-5A4E (2.85" Square x .040"T)	T140-A4E-602	\$150	\$120	\$90	\$80
PSI-5A4E (2.85" Square x .080"T)	T180-A4E-602	\$250	\$200	\$175	\$150



**PSI-5A4E SINGLE LAYER DISKS**  
**.0075" (.191mm) THICK**

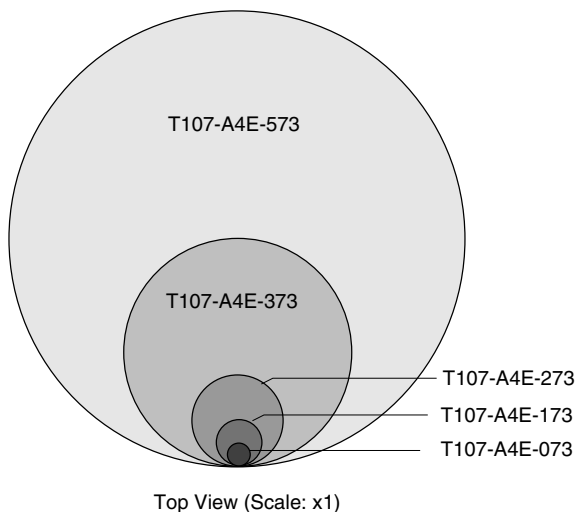

PART NUMBER	DIAMETER		CAPACITANCE
	inches	mm	nF (±10%)
T107-A4E-073	.125	3.2	.65
T107-A4E-173	.250	6.4	2.7
T107-A4E-273	.500	12.7	10.6
T107-A4E-373	1.25	31.8	66.4
T107-A4E-573	2.50	63.5	265

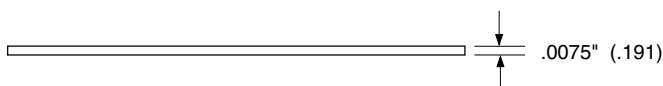

**PIEZOELECTRIC & MATERIAL PROPERTIES OF PSI-5A4E SINGLE LAYER DISKS**

**PIEZOELECTRIC**

Composition	Lead Zirconate Titanate	
Piezo Systems Material Designation	PSI 5A4E (Industry Type 5A, Navy Type II)	
Relative Dielectric Constant (@1KHz)	$K^T_{33}$	1800
Piezoelectric Strain Coefficient	$d_{33}$	$390 \times 10^{-12}$ meter/Volt
	$d_{31}$	$-190 \times 10^{-12}$ meter/Volt
Piezoelectric Voltage Coefficient	$g_{33}$	$24.0 \times 10^{-3}$ Volt meter/Newton
	$g_{31}$	$-11.6 \times 10^{-3}$ Volt meter/Newton
Coupling Coefficient	$k_{33}$	0.72
	$k_{31}$	0.32
Polarization Field	$E_p$	$2 \times 10^6$ Volt/meter
Initial Depolarization Field	$E_c$	$5 \times 10^5$ Volt/meter

**MECHANICAL**

Density	$\rho$	7800 Kg/meter <sup>3</sup>
Mechanical Q		80
Elastic Modulus	$Y^E_3$	$5.2 \times 10^{10}$ Newton/meter <sup>2</sup>
	$Y^E_1$	$6.6 \times 10^{10}$ Newton/meter <sup>2</sup>

**THERMAL**

Thermal Expansion Coefficient		$\sim 4 \times 10^{-6}$ meter/meter °C
Curie Temperature		350 °C

**ROHS** Compliant. Piezoceramic exempted from requirements of Article 4(1).

**ORDERING INFORMATION**

	PART NO.	1 pc.	5 pc.	25 pc.	100 pc.
PSI-5A4E (.125" Diameter x .0075"T)	T107-A4E-073	\$50	\$34	\$15	\$4
PSI-5A4E (.250" Diameter x .0075"T)	T107-A4E-173	\$60	\$40	\$20	\$6
PSI-5A4E (.500" Diameter x .0075"T)	T107-A4E-273	\$75	\$45	\$25	\$10
PSI-5A4E (1.25" Diameter x .0075"T)	T107-A4E-373	\$100	\$75	\$45	\$30
PSI-5A4E (2.50" Diameter x .0075"T)	T107-A4E-573	\$150	\$129	\$100	\$90

**PSI-5H4E PIEZOELECTRIC SINGLE SHEETS**

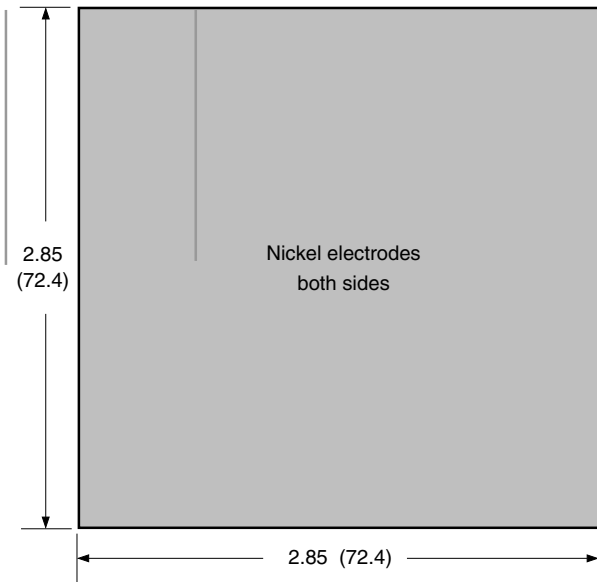

PART NUMBER	THICKNESS		CAPACITANCE
	mm		nF (±10%)
T105-H4E-602	.127		1250
T107-H4E-602	.191		850
T110-H4E-602	.267		610

.005 ± .0005	(.127 ± .013)
.0075 ± .0005	(.191 ± .013)
.0105 ± .0005	(.267 ± .013)

**PIEZOELECTRIC & MATERIAL PROPERTIES OF PSI-5H4E SINGLE SHEETS**

**PIEZOELECTRIC**

Composition	Lead Zirconate Titanate	
Piezo Systems Material Designation	Type 5H4E (Industry Type 5H, Navy Type VI)	
Relative Dielectric Constant (@1KHz)	$K^T_{33}$	3800
Piezoelectric Strain Coefficient	$d_{33}$	$650 \times 10^{-12}$ meter/Volt
	$d_{31}$	$-320 \times 10^{-12}$ meter/Volt
Piezoelectric Voltage Coefficient	$g_{33}$	$19.0 \times 10^{-3}$ Volt meter/Newton
	$g_{31}$	$-9.5 \times 10^{-3}$ Volt meter/Newton
Coupling Coefficient	$k_{33}$	.75
	$k_{31}$	.44
Polarization Field	$E_p$	$1.5 \times 10^6$ Volt/meter
Initial Depolarization Field	$E_c$	$3.0 \times 10^5$ Volt/meter

**MECHANICAL**

Density	$\rho$	7800	Kg/meter <sup>3</sup>
Mechanical Q		32	
Elastic Modulus	$Y^E_{33}$	$5.0 \times 10^{10}$	Newton/meter <sup>2</sup>
	$Y^E_{31}$	$6.2 \times 10^{10}$	Newton/meter <sup>2</sup>

**THERMAL**

Thermal Expansion Coefficient		$\sim 3 \times 10^{-6}$	meter/meter °C
Curie Temperature		230	°C

**ROHS** Compliant. Piezoceramic exempted from requirements of Article 4(1).

ORDERING INFORMATION	PART NO.	1 pc.	5 pc.	25 pc.	100 pc.
PSI-5H4E (2.85" Square x .005"T)	T105-H4E-602	\$100	\$70	\$50	\$35
PSI-5H4E (2.85" Square x .0075"T)	T107-H4E-602	\$100	\$60	\$40	\$30
PSI-5H4E (2.85" Square x .0105"T)	T110-H4E-602	\$100	\$70	\$50	\$35

### 2-PIEZO LAYER TRANSDUCERS - BENDERS & EXTENDERS USED AS MOTORS (ACTUATORS) AND GENERATORS (SENSORS)

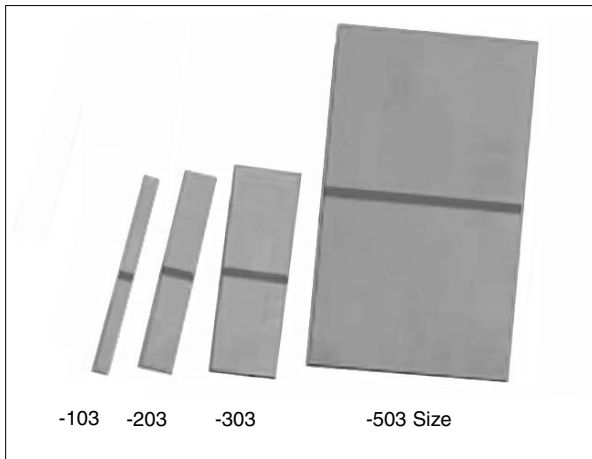

#### DESCRIPTION

Piezo Systems specializes in the manufacture of 2-piezo layer bending and extending elements, and offers a wide selection from which to choose. **It is important to note that the same 2-layer transducer can be used as either a bending motor, a bending generator, an extending motor or an extending generator.** Part numbers pertain to geometry and construction rather than usage.

**Mounting Options:** Transducer elements with a part number starting with T consist of the transducer alone. Pre-mounted and wired elements are discussed on [pages 38-51](#).

**Reinforcement Material:** Typically, the center shim reinforcement material has little effect on performance. Rather, it enhances other properties such as strength, thermal range, and magnetism.

**Size:** Larger elements (greater piezo volume) produce greater output energy.

**Polarization:** 2-piezo layer elements may have their layers poled in the same direction (Y-poled), or in opposite directions (X-poled). Polarization and wiring determine whether the element layers will be operate in serial or parallel mode ([see page 23](#)). In parallel mode, the user must access the center layer and attach a third wire.

**Performance:** The performance data for -103, -203, and -303 size transducers is based on a 1.0" active length. The performance data for -503 size transducers is a 2.0" active length.

#### Example 1: T220-A4-503X

This is an unmounted 2-piezo layer element, made with PSI-5A4E piezoceramic (nickel electrodes) and a brass center shim reinforcement. It is 2.50" long, 1.25" wide, .020" thick, and is X-poled. It may be used as:

- a bending motor poled for 2-wire series operation,
- a bending generator poled for 2-wire series operation,
- an extension motor poled for 3-wire parallel operation,
- an extension generator poled for 3-wire parallel operation.

#### Example 2: T220-A3NM-303Y

This is an unmounted 2-piezo layer transducer, made with PSI-5A3 piezoceramic (silver electrodes) and a non-magnetic center shim. It is 1.250" long, 0.50" wide, .020" thick, and is Y-poled. It may be used as:

- a non-magnetic bending motor poled for 3-wire parallel operation,
- a non-magnetic bending generator poled for 3-wire parallel operation,
- a non-magnetic extension motor poled for 2-wire series operation,
- a non-magnetic extension generator poled for 2-wire series operation.

#### TRANSDUCER PART NUMBERS

OPTIONS LISTED IN COLUMNS UNDER HEADINGS

TRANSDUCER PART NUMBERS								OPTIONS LISTED IN COLUMNS UNDER HEADINGS									
T		2		20		-		A4		-		503		X			
MOUNTING STYLES	NUMBER OF PIEZO LAYERS	THICKNESS DESIGNATION	PIEZOCERAMIC MATERIALS	REINFORCEMENT MATERIALS	SIZE DESIGNATION	POLARIZATION	INTENDED USE										
T - Transducer Only	2	15 (.015") 16 (.016") 19 (.019")	-A4 PSI-5A4E -H4 PSI-5H4E	(blank) - Standard Brass Shim SS - High Strength Stainless Steel	-103 -203 -303 -503	 X-Poled	Not used for Transducer Elements										
No Mount No Wires		20 (.020") 23 (.023") 26 (.026") 34 (.034")	-A3 PSI-5A3	CL - High Performance NO - No shim				 Y-Poled									

### 2-PIEZO LAYER TRANSDUCERS - BENDERS & EXTENDERS USED AS MOTORS AND GENERATORS

#### PIEZO MATERIALS

PIEZOCERAMIC MATERIAL	DESCRIPTION
A4	PSI-5A4E is an industry type 5A (Navy Type II) piezoceramic (see page 24). Thin vacuum sputtered nickel electrodes produce extremely low current leakage and low magnetic permeability. It operates over a wide temperature range and is relatively temperature insensitive (see page 62).
H4	PSI-5H4E is an industry type 5H (Navy Type VI) piezoceramic (see page 26). It has a high motion/volt and charge/newton rating, which is useful when voltage or force is limited. Thin vacuum sputtered nickel electrodes produce extremely low current leakage and magnetic permeability. However, its temperature range is limited and its properties are more sensitive to temperature (See page 62).
A3	PSI-5A3 is an industry type 5A (Navy Type II) piezoceramic. Its has totally non-magnetic, fired-on silver electrodes, operates over a wide temperature range, and is relatively temperature insensitive.

#### STANDARD TRANSDUCER THICKNESSES

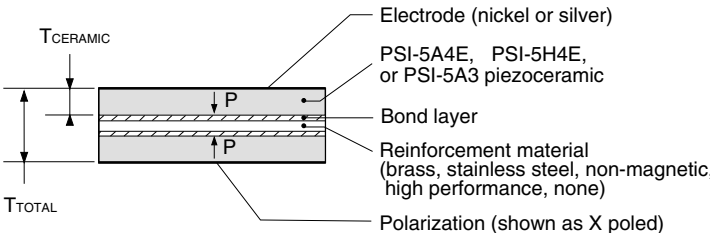

THICKNESS DESIGNATION	T <sub>TOTAL</sub>		T <sub>CERAMIC</sub>	
	Inches	(mm)	Inches	(mm)
15	.015	(.38)	.005	(.13)
16	.016	(.39)	.0075	(.19)
19	.019	(.48)	.0075	(.19)
20	.020	(.51)	.0075	(.19)
23	.023	(.58)	.0075	(.19)
26	.026	(.66)	.0105	(.27)
34	.034	(.86)	.0105	(.27)

#### STANDARD TRANSDUCER SIZES (L x W)

SIZE DESIGNATION	WIDTH		LENGTH	
	Inches	(mm)	Inches	(mm)
-103	.125	(3.2)	1.250	(31.8)
-203	.250	(6.4)	1.250	(31.8)
-303	.500	(12.7)	1.250	(31.8)
-503	1.250	(31.8)	2.500	(63.5)

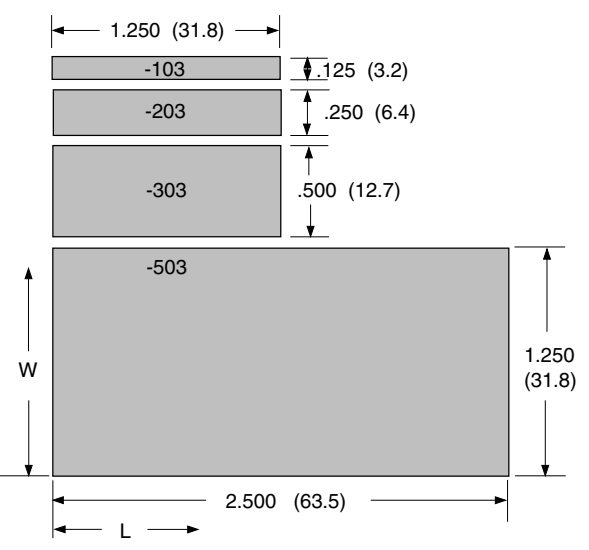

### 2-PIEZO LAYER BENDING MOTORS STANDARD - BRASS REINFORCED

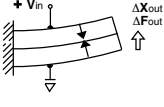
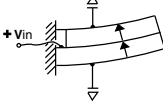
PERFORMANCE: BRASS SHIM BENDING MOTORS (Cantilever Mount)										VALUES TO BE USED AS GUIDELINES
PART NUMBERS (BRASS REINFORCED BENDER)		WEIGHT (Grams)	STIFFNESS (N/m)	CAPACITANCE (nF)		RATED VOLTAGE (Vp) (Series Operation)	RATED VOLTAGE (Vp) (Parallel Operation)	RESONANT FREQUENCY ① (Hz)	FREE DEFLECTION ① (µm)	BLOCKED FORCE ① (N)
 X-poled for series bending operation (2 wire).				 Y-poled for parallel bending operation (3 wire).						
<b>.015" (.38mm) THICK</b>										
T215-A4-103X	T215-A4-103Y	.30	1.3x10 <sup>2</sup>	5	20	± 120	± 60	270	± 300	± .04
T215-A4-203X	T215-A4-203Y	.60	2.7x10 <sup>2</sup>	10	40	± 120	± 60	270	± 300	± .08
T215-A4-303X	T215-A4-303Y	1.2	5.3x10 <sup>2</sup>	20	80	± 120	± 60	270	± 300	± .16
T215-A4-503X	T215-A4-503Y	6.0	1.6x10 <sup>2</sup>	100	400	± 120	± 60	67	± 1200	± .20
T215-H4-103X	T215-H4-103Y	.30	1.3x10 <sup>2</sup>	8	32	± 80	± 40	270	± 300	± .04
T215-H4-203X	T215-H4-203Y	.60	2.7x10 <sup>2</sup>	16	64	± 80	± 40	270	± 300	± .08
T215-H4-303X	T215-H4-303Y	1.2	5.3x10 <sup>2</sup>	32	128	± 80	± 40	270	± 300	± .16
T215-H4-503X	T215-H4-503Y	6.0	1.6x10 <sup>2</sup>	160	640	± 80	± 40	67	± 1200	± .20
<b>.020" (.51mm) THICK</b>										
T220-A4-103X	T220-A4-103Y	.40	2.8x10 <sup>2</sup>	3.5	14	± 180	± 90	350	± 250	± .07
T220-A4-203X	T220-A4-203Y	.80	5.6x10 <sup>2</sup>	7	29	± 180	± 90	350	± 250	± .14
T220-A4-303X	T220-A4-303Y	1.6	1.1x10 <sup>3</sup>	15	58	± 180	± 90	350	± 250	± .28
T220-A4-503X	T220-A4-503Y	8.0	3.5x10 <sup>2</sup>	73	292	± 180	± 90	88	± 1000	± .35
T220-H4-103X	T220-H4-103Y	.40	2.8x10 <sup>2</sup>	6	24	± 120	± 60	350	± 250	± .07
T220-H4-203X	T220-H4-203Y	.80	5.6x10 <sup>2</sup>	12	48	± 120	± 60	350	± 250	± .14
T220-H4-303X	T220-H4-303Y	1.6	1.1x10 <sup>3</sup>	24	96	± 120	± 60	350	± 250	± .28
T220-H4-503X	T220-H4-503Y	8.0	3.5x10 <sup>2</sup>	120	480	± 120	± 60	88	± 1000	± .35
<b>.026" (.66mm) THICK</b>										
T226-A4-103X	T226-A4-103Y	.51	0.7x10 <sup>3</sup>	2.5	10	± 250	± 125	440	± 175	± .13
T226-A4-203X	T226-A4-203Y	1.1	1.5x10 <sup>3</sup>	5	20	± 250	± 125	440	± 175	± .25
T226-A4-303X	T226-A4-303Y	2.1	3.0x10 <sup>3</sup>	10	40	± 250	± 125	440	± 175	± .50
T226-A4-503X	T226-A4-503Y	10.3	0.9x10 <sup>3</sup>	50	200	± 250	± 125	110	± 700	± .62
T226-H4-103X	T226-H4-103Y	.51	0.7x10 <sup>3</sup>	4	16	± 165	± 82	440	± 175	± .13
T226-H4-203X	T226-H4-203Y	1.1	1.5x10 <sup>3</sup>	8	32	± 165	± 82	440	± 175	± .25
T226-H4-303X	T226-H4-303Y	2.1	3.0x10 <sup>3</sup>	17	68	± 165	± 82	440	± 175	± .50
T226-H4-503X	T226-H4-503Y	10.3	0.9x10 <sup>3</sup>	85	340	± 165	± 82	110	± 700	± .62

① -103, -203, and -303 performance is based on a 1.0" bending length. -503 performance based on 2.0" bending length.

Suitable for cryogenic use. **ROHS**: Compliant. Piezo exempt.

PRICES: (See page 33)

### 2-PIEZO LAYER BENDING GENERATORS STANDARD - BRASS REINFORCED

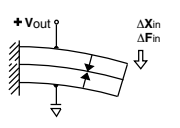
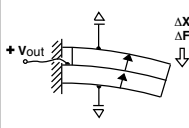
PERFORMANCE: BRASS SHIM BENDING GENERATORS (Cantilever mount)						VALUES TO BE USED AS GUIDELINES				
PART NUMBERS (BRASS REINFORCED BENDER)		WEIGHT (grams)	STIFFNESS (N/m)	CAPACITANCE (nF) (Series Operation)	CAPACITANCE (nF) (Parallel Operation)	RATED TIP DEFLECTION ① (mm <sup>peak</sup> )	RATED FREQUENCY ① (Hz)	OPEN CIRCUIT VOLTAGE ① At rated deflection, parallel operation (V <sup>peak</sup> )	CLOSED CIRCUIT CURRENT ① Per sinusoidal cycle, at rated deflection, parallel operation. (μA <sup>peak</sup> / Hz)	RATED OUTPUT POWER ① At rated deflection and frequency (mW <sub>rms</sub> )
										
X-poled for series bending operation (2 wire).										
Y-poled for parallel bending operation (3 wire).										
<b>.015" (.38mm) THICK</b>										
T215-A4-103X	T215-A4-103Y	.30	1.3x10 <sup>2</sup>	5	20	± .51	250	± 12	± 2	0.8
T215-A4-203X	T215-A4-203Y	.60	2.7x10 <sup>2</sup>	10	40	± .51	250	± 12	± 4	1.5
T215-A4-303X	T215-A4-303Y	1.2	5.3x10 <sup>2</sup>	20	80	± .51	250	± 12	± 8	3.0
T215-A4-503X	T215-A4-503Y	6.0	1.6x10 <sup>2</sup>	100	400	± 2.1	63	± 12	± 42	4.0
T215-H4-103X	T215-H4-103Y	.30	1.3x10 <sup>2</sup>	8	32	± .51	250	± 10	± 3	0.9
T215-H4-203X	T215-H4-203Y	.60	2.7x10 <sup>2</sup>	16	64	± .51	250	± 10	± 7	2.2
T215-H4-303X	T215-H4-303Y	1.2	5.3x10 <sup>2</sup>	32	128	± .51	250	± 10	± 14	4.4
T215-H4-503X	T215-H4-503Y	6.0	1.6x10 <sup>2</sup>	160	640	± 2.1	63	± 10	± 69	5.4
<b>.020" (.51mm) THICK</b>										
T220-A4-103X	T220-A4-103Y	.40	2.8x10 <sup>2</sup>	3.5	14	± .38	320	± 16	± 1.5	1.0
T220-A4-203X	T220-A4-203Y	.80	5.6x10 <sup>2</sup>	7	29	± .38	320	± 16	± 3	1.9
T220-A4-303X	T220-A4-303Y	1.6	1.1x10 <sup>3</sup>	15	58	± .38	320	± 16	± 7	4.5
T220-A4-503X	T220-A4-503Y	8.0	3.5x10 <sup>2</sup>	73	292	± 1.57	80	± 16	± 34	5.4
T220-H4-103X	T220-H4-103Y	.40	2.8x10 <sup>2</sup>	6	24	± .38	320	± 13	± 2.5	1.3
T220-H4-203X	T220-H4-203Y	.80	5.6x10 <sup>2</sup>	12	48	± .38	320	± 13	± 5	2.6
T220-H4-303X	T220-H4-303Y	1.6	1.1x10 <sup>3</sup>	24	96	± .38	320	± 13	± 11	5.7
T220-H4-503X	T220-H4-503Y	8.0	3.5x10 <sup>2</sup>	120	480	± 1.57	80	± 13	± 55	7.2
<b>.026" (.66mm) THICK</b>										
T226-A4-103X	T226-A4-103Y	.51	0.7x10 <sup>3</sup>	2.5	10	± .30	400	± 22	± 1	1.1
T226-A4-203X	T226-A4-203Y	1.1	1.5x10 <sup>3</sup>	5	20	± .30	400	± 22	± 2	2.2
T226-A4-303X	T226-A4-303Y	2.1	3.0x10 <sup>3</sup>	10	40	± .30	400	± 22	± 5	5.5
T226-A4-503X	T226-A4-503Y	10.3	0.9x10 <sup>3</sup>	50	200	± 1.22	100	± 22	± 24	6.6
T226-H4-103X	T226-H4-103Y	.51	0.7x10 <sup>3</sup>	4	16	± .30	400	± 18	± 2	1.8
T226-H4-203X	T226-H4-203Y	1.1	1.5x10 <sup>3</sup>	8	32	± .30	400	± 18	± 4	3.6
T226-H4-303X	T226-H4-303Y	2.1	3.0x10 <sup>3</sup>	17	68	± .30	400	± 18	± 8	7.2
T226-H4-503X	T226-H4-503Y	10.3	0.9x10 <sup>3</sup>	85	340	± 1.22	100	± 18	± 39	8.8

① -103, -203, and -303 performance is based on a 1.0" bending length. -503 performance based on 2.0" bending length. Suitable for cryogenic use. **ROHS: Compliant. Piezo exempt.** PRICES: (See page 33)

### 2-PIEZO LAYER EXTENSION MOTORS STANDARD - BRASS REINFORCED

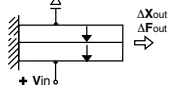
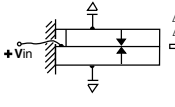
PERFORMANCE: BRASS SHIM EXTENSION MOTORS										VALUES TO BE USED AS GUIDELINES
PART NUMBERS (BRASS REINFORCED EXTENDER)		WEIGHT (Grams)	STIFFNESS (N/m)	CAPACITANCE (nF) (Series Operation)	CAPACITANCE (nF) (Parallel Operation)	RATED VOLTAGE (Vp) (Series Operation)	RATED VOLTAGE (Vp) (Parallel Operation)	RESONANT FREQUENCY ① (Hz)	FREE DEFLECTION ① (µm)	BLOCKED FORCE ① (N)
 Y-poled for series extension operation (2 wire).	 X-poled for parallel extension operation (3 wire).									
<b>.015" (.38mm) THICK</b>										
T215-A4-103Y	T215-A4-103X	.30	2x10 <sup>6</sup>	5	20	± 120	± 60	30,000	± 2.8	± 5
T215-A4-203Y	T215-A4-203X	.60	3x10 <sup>6</sup>	10	40	± 120	± 60	30,000	± 2.8	± 9
T215-A4-303Y	T215-A4-303X	1.2	6x10 <sup>6</sup>	20	80	± 120	± 60	30,000	± 2.8	± 19
T215-A4-503Y	T215-A4-503X	6.0	8x10 <sup>6</sup>	100	400	± 120	± 60	15,000	± 5.7	± 47
T215-H4-103Y	T215-H4-103X	.30	2x10 <sup>6</sup>	8	32	± 80	± 40	30,000	± 2.8	± 5
T215-H4-203Y	T215-H4-203X	.60	3x10 <sup>6</sup>	16	64	± 80	± 40	30,000	± 2.8	± 9
T215-H4-303Y	T215-H4-303X	1.2	6x10 <sup>6</sup>	32	128	± 80	± 40	30,000	± 2.8	± 19
T215-H4-503Y	T215-H4-503X	6.0	8x10 <sup>6</sup>	160	640	± 80	± 40	15,000	± 5.7	± 47
<b>.020" (.51mm) THICK</b>										
T220-A4-103Y	T220-A4-103X	.40	2x10 <sup>6</sup>	3.5	14	± 180	± 90	29,500	± 3.2	± 7
T220-A4-203Y	T220-A4-203X	.80	4x10 <sup>6</sup>	7	29	± 180	± 90	29,500	± 3.2	± 14
T220-A4-303Y	T220-A4-303X	1.6	9x10 <sup>6</sup>	15	58	± 180	± 90	29,500	± 3.2	± 29
T220-A4-503Y	T220-A4-503X	8.0	11x10 <sup>6</sup>	73	292	± 180	± 90	14,750	± 6.4	± 72
T220-H4-103Y	T220-H4-103X	.40	2x10 <sup>6</sup>	6.0	24	± 120	± 60	29,500	± 3.2	± 7
T220-H4-203Y	T220-H4-203X	.80	4x10 <sup>6</sup>	12	48	± 120	± 60	29,500	± 3.2	± 14
T220-H4-303Y	T220-H4-303X	1.6	9x10 <sup>6</sup>	24	96	± 120	± 60	29,500	± 3.2	± 29
T220-H4-503Y	T220-H4-503X	8.0	11x10 <sup>6</sup>	120	480	± 120	± 60	14,750	± 6.4	± 72
<b>.026" (.66mm) THICK</b>										
T226-A4-103Y	T226-A4-103X	.51	3x10 <sup>6</sup>	2.5	10	± 260	± 130	29,000	± 3.4	± 10
T226-A4-203Y	T226-A4-203X	1.1	6x10 <sup>6</sup>	5	20	± 260	± 130	29,000	± 3.4	± 20
T226-A4-303Y	T226-A4-303X	2.1	12x10 <sup>6</sup>	10	40	± 260	± 130	29,000	± 3.4	± 40
T226-A4-503Y	T226-A4-503X	10.3	15x10 <sup>6</sup>	50	200	± 260	± 130	14,500	± 6.8	± 100
T226-H4-103Y	T226-H4-103X	.51	3x10 <sup>6</sup>	4	16	± 170	± 85	29,000	± 3.4	± 10
T226-H4-203Y	T226-H4-203X	1.1	6x10 <sup>6</sup>	8	32	± 170	± 85	29,000	± 3.4	± 20
T226-H4-303Y	T226-H4-303X	2.1	12x10 <sup>6</sup>	17	68	± 170	± 85	29,000	± 3.4	± 40
T226-H4-503Y	T226-H4-503X	10.3	15x10 <sup>6</sup>	85	340	± 170	± 85	14,500	± 6.8	± 100

① -103, -203, and -303 performance is based on a 1.0" extension length. -503 performance based on 2.0" extension length. Suitable for cryogenic use. **ROHS: Compliant. Piezo exempt.**

### 2-PIEZO LAYER EXTENSION GENERATORS STANDARD - BRASS REINFORCED

PERFORMANCE: BRASS SHIM EXTENSION GENERATORS										VALUES TO BE USED AS GUIDELINES
PART NUMBERS (BRASS REINFORCED EXTENDER)		WEIGHT (grams)	STIFFNESS (N/m)	CAPACITANCE (nF) (Series Operation)	CAPACITANCE (nF) (Parallel Operation)	RATED TIP DEFLECTION ① ( $\mu\text{m}_{\text{peak}}$ )	RATED FREQUENCY ① At rated tip deflection (Hz)	OPEN CIRCUIT VOLTAGE ① At rated deflection, parallel operation (V <sub>peak</sub> )	CLOSED CIRCUIT CURRENT ① Per sinusoidal cycle, at rated deflection, parallel operation. ( $\mu\text{A}_{\text{peak}}$ / Hz)	RATED OUTPUT POWER ① At rated deflection and frequency, parallel operation. (mW <sub>rms</sub> )
Y-poled for series extension operation (2 wire).	X-poled for parallel extension operation (3 wire).									
<b>.015" (.38mm) THICK</b>										
T215-A4-103Y	T215-A4-103X	.30	2x10 <sup>6</sup>	5	20	± 13	1000	± 57	± 5	36
T215-A4-203Y	T215-A4-203X	.60	3x10 <sup>6</sup>	10	40	± 13	1000	± 57	± 11	78
T215-A4-303Y	T215-A4-303X	1.2	6x10 <sup>6</sup>	20	80	± 13	1000	± 57	± 21	150
T215-A4-503Y	T215-A4-503X	6.0	8x10 <sup>6</sup>	100	400	± 25	500	± 57	± 110	392
T215-H4-103Y	T215-H4-103X	.30	2x10 <sup>6</sup>	8	32	± 13	1000	± 47	± 8	47
T215-H4-203Y	T215-H4-203X	.60	3x10 <sup>6</sup>	16	64	± 13	1000	± 47	± 17	100
T215-H4-303Y	T215-H4-303X	1.2	6x10 <sup>6</sup>	32	128	± 13	1000	± 47	± 33	194
T215-H4-503Y	T215-H4-503X	6.0	8x10 <sup>6</sup>	160	640	± 25	500	± 47	± 172	510
<b>.020" (.51mm) THICK</b>										
T220-A4-103Y	T220-A4-103X	.40	2x10 <sup>6</sup>	3.5	14	± 13	1500	± 82	± 5	77
T220-A4-203Y	T220-A4-203X	.80	4x10 <sup>6</sup>	7	29	± 13	1500	± 82	± 11	170
T220-A4-303Y	T220-A4-303X	1.6	9x10 <sup>6</sup>	15	58	± 13	1500	± 82	± 21	320
T220-A4-503Y	T220-A4-503X	8.0	11x10 <sup>6</sup>	73	292	± 25	750	± 82	± 110	850
T220-H4-103Y	T220-H4-103X	.40	2x10 <sup>6</sup>	6	24	± 13	1500	± 67	± 8	100
T220-H4-203Y	T220-H4-203X	.80	4x10 <sup>6</sup>	12	48	± 13	1500	± 67	± 17	210
T220-H4-303Y	T220-H4-303X	1.6	9x10 <sup>6</sup>	24	96	± 13	1500	± 67	± 33	410
T220-H4-503Y	T220-H4-503X	8.0	11x10 <sup>6</sup>	120	480	± 25	750	± 67	± 172	1,100
<b>.026" (.66mm) THICK</b>										
T226-A4-103Y	T226-A4-103X	.51	3x10 <sup>6</sup>	2.5	10	± 13	2000	± 116	± 5	150
T226-A4-203Y	T226-A4-203X	1.1	6x10 <sup>6</sup>	5	20	± 13	2000	± 116	± 11	320
T226-A4-303Y	T226-A4-303X	2.1	12x10 <sup>6</sup>	10	40	± 13	2000	± 116	± 21	610
T226-A4-503Y	T226-A4-503X	10.3	15x10 <sup>6</sup>	50	200	± 25	1000	± 116	± 110	1,600
T226-H4-103Y	T226-H4-103X	.51	3x10 <sup>6</sup>	4	16	± 13	2000	± 95	± 8	190
T226-H4-203Y	T226-H4-203X	1.1	6x10 <sup>6</sup>	8	32	± 13	2000	± 95	± 17	400
T226-H4-303Y	T226-H4-303X	2.1	12x10 <sup>6</sup>	17	68	± 13	2000	± 95	± 33	780
T226-H4-503Y	T226-H4-503X	10.3	15x10 <sup>6</sup>	85	340	± 25	1000	± 95	± 172	2,000

① -103, -203, and -303 performance is based on a 1.0" extension length. -503 performance based on 2.0" extension length. Suitable for cryogenic use. **ROHS: Compliant. Piezo exempt.** RICES: (See page 33)

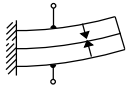
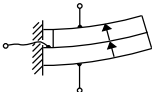
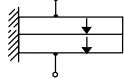
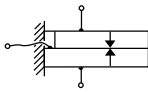

### 2-PIEZO LAYER BENDER & EXTENDER PRICES STANDARD - BRASS REINFORCED

PRICE & ORDERING INFORMATION								
BRASS REINFORCED BENDERS		BRASS REINFORCED EXTENDERS						
								
X-poled for series bending operation (2 wire).	Y-poled for parallel bending operation (3 wire).	Y-poled for series extension operation (2 wire).	X-poled for parallel extension operation (3 wire).					
				UNIT PRICE				
				1 pc	5	25	100	
<b>.015" (.38mm) THICK</b>								
T215-A4-103X	T215-A4-103Y	T215-A4-103Y	T215-A4-103X	\$75	\$35	\$18	\$12	
T215-A4-203X	T215-A4-203Y	T215-A4-203Y	T215-A4-203X	\$80	\$50	\$25	\$15	
T215-A4-303X	T215-A4-303Y	T215-A4-303Y	T215-A4-303X	\$90	\$60	\$30	\$22	
T215-A4-503X	T215-A4-503Y	T215-A4-503Y	T215-A4-503X	\$150	\$100	\$75	\$65	
T215-H4-103X	T215-H4-103Y	T215-H4-103Y	T215-H4-103X	\$75	\$35	\$18	\$12	
T215-H4-203X	T215-H4-203Y	T215-H4-203Y	T215-H4-203X	\$80	\$50	\$25	\$15	
T215-H4-303X	T215-H4-303Y	T215-H4-303Y	T215-H4-303X	\$90	\$60	\$30	\$22	
T215-H4-503X	T215-H4-503Y	T215-H4-503Y	T215-H4-503X	\$150	\$100	\$75	\$65	
<b>.020" (.51mm) THICK</b>								
T220-A4-103X	T220-A4-103Y	T220-A4-103Y	T220-A4-103X	\$75	\$30	\$15	\$9	
T220-A4-203X	T220-A4-203Y	T220-A4-203Y	T220-A4-203X	\$80	\$40	\$20	\$12	
T220-A4-303X	T220-A4-303Y	T220-A4-303Y	T220-A4-303X	\$90	\$50	\$25	\$18	
T220-A4-503X	T220-A4-503Y	T220-A4-503Y	T220-A4-503X	\$125	\$90	\$70	\$60	
T220-H4-103X	T220-H4-103Y	T220-H4-103Y	T220-H4-103X	\$75	\$30	\$15	\$9	
T220-H4-203X	T220-H4-203Y	T220-H4-203Y	T220-H4-203X	\$80	\$40	\$20	\$12	
T220-H4-303X	T220-H4-303Y	T220-H4-303Y	T220-H4-303X	\$90	\$50	\$25	\$18	
T220-H4-503X	T220-H4-503Y	T220-H4-503Y	T220-H4-503X	\$125	\$90	\$70	\$60	
<b>.026" (.66mm) THICK</b>								
T226-A4-103X	T226-A4-103Y	T226-A4-103Y	T226-A4-103X	\$75	\$35	\$18	\$12	
T226-A4-203X	T226-A4-203Y	T226-A4-203Y	T226-A4-203X	\$80	\$50	\$25	\$15	
T226-A4-303X	T226-A4-303Y	T226-A4-303Y	T226-A4-303X	\$90	\$60	\$30	\$22	
T226-A4-503X	T226-A4-503Y	T226-A4-503Y	T226-A4-503X	\$150	\$100	\$75	\$65	
T226-H4-103X	T226-H4-103Y	T226-H4-103Y	T226-H4-103X	\$75	\$35	\$18	\$12	
T226-H4-203X	T226-H4-203Y	T226-H4-203Y	T226-H4-203X	\$80	\$50	\$25	\$15	
T226-H4-303X	T226-H4-303Y	T226-H4-303Y	T226-H4-303X	\$90	\$60	\$30	\$22	
T226-H4-503X	T226-H4-503Y	T226-H4-503Y	T226-H4-503X	\$150	\$100	\$75	\$65	

### 2-PIEZO LAYER BENDING MOTORS HIGH PERFORMANCE - USING 5A4E PIEZOCERAMIC

#### DESCRIPTION: HIGH PERFORMANCE BENDING MOTORS

Composite reinforced (CL) bending elements are available for use in applications requiring the highest performance. These elements provide higher motion, higher force, and higher response in the same size package. They are constructed of 5A4E piezoceramic and are X-poled for series bending operation.

**Custom** sizes, configurations and mounting options upon request\*. Maximum size: 2.65" (67.3mm) long x 2.65" (67.3mm) wide.

Delivery: Typically stocked for "off-the-shelf" delivery.

#### PERFORMANCE: 5A4E - HIGH PERFORMANCE BENDER (Cantilever Mount)

VALUES TO BE USED AS GUIDELINES

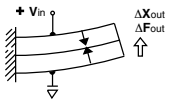
PART NUMBERS HIGH PERFORMANCE BENDERS	WEIGHT (Grams)	STIFFNESS (N/m)	CAPACITANCE (nF) (Series Operation)	RATED VOLTAGE (Vp) (Series Operation)	RESONANT FREQUENCY ① (Hz)	FREE DEFLECTION ① (µm)	BLOCKED FORCE ① (N)	PRICE & ORDERING INFORMATION				
								1 pc.	5	25	100	
								UNIT PRICE				
 <p>X-poled for series bending operation (2 wire)</p>												
<b>.015" (.38mm) THICK</b>												
T215-A4CL-103X	.22	1.0x10 <sup>2</sup>	6	± 120	275	± 370	± .04	\$75	\$40	\$20	\$13	
T215-A4CL-203X	.45	2.0x10 <sup>2</sup>	11	± 120	275	± 370	± .09	\$80	\$55	\$28	\$16	
T215-A4CL-303X	.90	4.0x10 <sup>2</sup>	22	± 120	275	± 370	± .17	\$90	\$65	\$33	\$25	
T215-A4CL-503X	4.5	1.3x10 <sup>2</sup>	110	± 120	68	± 1480	± .23	\$160	\$115	\$82	\$72	
<b>.019" (.48mm) THICK</b>												
T219-A4CL-103X	.32	2.6x10 <sup>2</sup>	4	± 180	360	± 305	± .08	\$75	\$35	\$17	\$10	
T219-A4CL-203X	.64	5.2x10 <sup>2</sup>	8	± 180	360	± 305	± .16	\$80	\$45	\$22	\$13	
T219-A4CL-303X	1.3	1.0x10 <sup>3</sup>	16	± 180	360	± 305	± .31	\$90	\$55	\$28	\$20	
T219-A4CL-503X	6.4	3.2x10 <sup>2</sup>	76	± 180	90	± 1,220	± .39	\$130	\$100	\$77	\$65	
<b>.023" (.58mm) THICK</b>												
T223-A4CL-103X	.34	3.9x10 <sup>2</sup>	4	± 180	425	± 254	± .10	\$80	\$37	\$18	\$11	
T223-A4CL-203X	.68	8.3x10 <sup>2</sup>	8	± 180	425	± 254	± .21	\$90	\$48	\$24	\$14	
T223-A4CL-303X	1.4	1.7x10 <sup>3</sup>	16	± 180	425	± 254	± .42	\$100	\$60	\$30	\$22	
T223-A4CL-503X	6.8	5.2x10 <sup>2</sup>	80	± 180	106	± 1,016	± .53	\$150	\$110	\$82	\$70	
<b>.034" (.86mm) THICK</b>												
T234-A4CL-103X	.48	1.1x10 <sup>3</sup>	2.7	± 250	620	± 160	± .18	\$100	\$45	\$25	\$15	
T234-A4CL-203X	.97	2.2x10 <sup>3</sup>	5.5	± 250	620	± 160	± .36	\$110	\$60	\$35	\$18	
T234-A4CL-303X	1.9	4.5x10 <sup>3</sup>	11	± 250	620	± 160	± .72	\$125	\$70	\$40	\$25	
T234-A4CL-503X	9.7	1.4x10 <sup>3</sup>	55	± 250	152	± 640	± .89	\$175	\$130	\$90	\$75	

① -103, -203, and -303 performance based on 1.0" bending length. -503 performance based on 2.0" bending length.

\* Quick-Mounts and Double-Quick-Mounts for High Performance elements are wired for series operation.

Suitable for cyrogenic use. **ROHS: Compliant. Piezo exempt.**

### 2-PIEZO LAYER BENDING MOTOR HIGH PERFORMANCE - USING 5H4E PIEZOCERAMIC

#### DESCRIPTION: HIGH PERFORMANCE BENDING MOTORS

Composite reinforced (CL) bending elements are available for use in applications requiring the highest performance. These elements provide higher motion, higher force, and higher response in the same size package. They are constructed of 5H4E piezoceramic and are X-poled for series bending operation.

Custom sizes, configurations and mounting options upon request\*. Maximum size: 2.65" (67.3mm) long x 2.65" (67.3mm) wide.

Delivery: Typically stocked for "off-the-shelf" delivery.

#### PERFORMANCE: 5H4E - HIGH PERFORMANCE BENDER (Cantilever Mount)

VALUES TO BE USED AS GUIDELINES

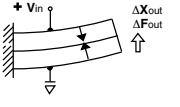
PART NUMBERS HIGH PERFORMANCE BENDERS	WEIGHT (Grams)	STIFFNESS (N/m)	CAPACITANCE (nF) (Series Operation)	RATED VOLTAGE (Vp) (Series Operation)	RESONANT FREQUENCY ① (Hz)	FREE DEFLECTION ① (µm)	BLOCKED FORCE ① (N)	PRICE & ORDERING INFORMATION				
								1 pc.	5	25	100	
								UNIT PRICE				
 <p>X-poled for series bending operation (2 wire)</p>												
<b>.015" (.38mm) THICK</b>												
T215-H4CL-103X	.22	1.2x10 <sup>2</sup>	9	± 80	270	± 370	± .045	\$75	\$40	\$20	\$13	
T215-H4CL-203X	.45	2.2x10 <sup>2</sup>	17	± 80	270	± 370	± .08	\$80	\$55	\$28	\$16	
T215-H4CL-303X	.90	4.6x10 <sup>2</sup>	35	± 80	270	± 370	± .17	\$90	\$65	\$33	\$25	
T215-H4CL-503X	4.5	1.6x10 <sup>2</sup>	175	± 80	68	± 1,480	± .23	\$160	\$115	\$82	\$72	
<b>.019" (.48mm) THICK</b>												
T219-H4CL-103X	.32	2.6x10 <sup>2</sup>	6.5	± 120	350	± 305	± .08	\$75	\$35	\$17	\$10	
T219-H4CL-203X	.64	5.2x10 <sup>2</sup>	13	± 120	350	± 305	± .16	\$80	\$45	\$22	\$13	
T219-H4CL-303X	1.3	1.0x10 <sup>3</sup>	26	± 120	350	± 305	± .31	\$90	\$55	\$28	\$20	
T219-H4CL-503X	6.4	3.2x10 <sup>2</sup>	130	± 120	88	± 1,220	± .39	\$130	\$100	\$77	\$65	
<b>.023" (.58mm) THICK</b>												
T223-H4CL-103X	.34	4.0x10 <sup>2</sup>	6.5	± 120	440	± 270	± .11	\$80	\$37	\$18	\$11	
T223-H4CL-203X	.68	8.1x10 <sup>2</sup>	13	± 120	440	± 270	± .22	\$90	\$48	\$24	\$14	
T223-H4CL-303X	1.4	1.6x10 <sup>3</sup>	26	± 120	440	± 270	± .44	\$100	\$60	\$30	\$22	
T223-H4CL-503X	6.8	5.1x10 <sup>2</sup>	130	± 120	110	± 1,080	± .55	\$150	\$110	\$82	\$70	
<b>.034" (.86mm) THICK</b>												
T234-H4CL-103X	.48	1.1x10 <sup>3</sup>	4.5	± 170	600	± 165	± .18	\$100	\$45	\$25	\$15	
T234-H4CL-203X	.97	2.2x10 <sup>3</sup>	9	± 170	600	± 165	± .36	\$110	\$60	\$35	\$18	
T234-H4CL-303X	1.9	4.3x10 <sup>3</sup>	18	± 170	600	± 165	± .71	\$125	\$70	\$40	\$25	
T234-H4CL-503X	9.7	1.3x10 <sup>3</sup>	88	± 170	150	± 660	± .89	\$175	\$130	\$90	\$75	

① -103, -203, and -303 performance based on 1.0" bending length. -503 performance based on 2.0" bending length.

\* Quick-Mounts and Double-Quick-Mounts for High Performance elements are wired for series operation.

Suitable for cyrogenic use. **ROHS: Compliant. Piezo exempt.**

### 2-PIEZO LAYER BENDING & EXTENSION MOTORS NON-MAGNETIC

#### DESCRIPTION

Non-magnetic piezo bending and extension motors are fabricated using piezoceramic with non-magnetic electrodes and non-magnetic reinforcing materials. They exhibit no magnetic permeability and generate no external magnetic field.

**Performance** is similar to standard brass shim elements of similar size and thickness (see pages 29-32) but capacitance, deflection, and force are reduced by ~ 15%. Suitable for cryogenic and vacuum use.

**Custom** sizes upon request. Maximum size: 1.75" (44.5mm) long x 1.75" (44.5mm) wide.

**ROHS:** Compliant. Piezo exempt.

PERFORMANCE: NON-MAGNETIC BENDING MOTORS (Cantilever Mount)										VALUES TO BE USED AS GUIDELINES	
PART NUMBERS: NON-MAGNETIC BENDING MOTOR		WEIGHT (Grams)	STIFFNESS (N/m)	CAPACITANCE (nF)		RATED VOLTAGE (Vp)		RESONANT FREQUENCY ① (Hz)	FREE DEFLECTION ① (µm)	BLOCKED FORCE ① (N)	
X-poled for series bending operation (2 wire)	Y-poled for parallel bending operation (3 wire)			(Series Operation)	(Parallel Operation)	(Series Operation)	(Parallel Operation)				
<b>.020" (.51mm) THICK</b>											
T220-A3NM-103X	T220-A3NM-103Y	.40	2.5x10 <sup>2</sup>	2.9	12	± 180	± 90	350	± 210	± .06	
T220-A3NM-203X	T220-A3NM-203Y	.80	5.5x10 <sup>2</sup>	5.9	24	± 180	± 90	350	± 210	± .12	
T220-A3NM-303X	T220-A3NM-303Y	1.6	1.1x10 <sup>3</sup>	13	49	± 180	± 90	350	± 210	± .23	

PERFORMANCE: PERFORMANCE: NON-MAGNETIC EXTENSION MOTORS										VALUES TO BE USED AS GUIDELINES	
NON-MAGNETIC EXTENSION MOTORS		WEIGHT (Grams)	STIFFNESS (N/m)	CAPACITANCE (nF)		RATED VOLTAGE (Vp)		RESONANT FREQUENCY ① (Hz)	FREE DEFLECTION ① (µm)	BLOCKED FORCE ① (N)	
Y-poled for series extension operation (2 wire).	X-poled for parallel extension operation (3 wire).			(Series Operation)	(Parallel Operation)	(Series Operation)	(Parallel Operation)				
<b>.020" (.51mm) THICK</b>											
T220-A3NM-103Y	T220-A3NM-103X	.40	2x10 <sup>6</sup>	2.9	12	± 180	± 90	29,500	± 2.7	± 5.9	
T220-A3NM-203Y	T220-A3NM-203X	.80	4x10 <sup>6</sup>	5.9	24	± 180	± 90	29,500	± 2.7	± 12	
T220-A3NM-303Y	T220-A3NM-303X	1.6	9x10 <sup>6</sup>	13	49	± 180	± 90	29,500	± 2.7	± 24	

① -103, -203, and -303 performance based on 1.0" length. -503 performance based on 2.0" length.

PRICE & ORDERING INFORMATION				1 pc	5	25	100
		X-POLED	Y-POLED	UNIT PRICE			
Non-Magnetic Element, -103 size		T220-A3NM-103X	T220-A3NM-103Y	\$110	\$45	\$22	\$13
Non-Magnetic Element, -203 size		T220-A3NM-203X	T220-A3NM-203Y	\$120	\$60	\$30	\$18
Non-Magnetic Element, -303 size		T220-A3NM-303X	T220-A3NM-303Y	\$135	\$75	\$45	\$33

### 2-PIEZO LAYER BENDING MOTORS HIGH STRENGTH - STAINLESS STEEL REINFORCED

#### DESCRIPTION

High strength piezo transducers, fabricated using stainless steel shim reinforcement, provide ~ 25% greater strength than standard brass shim elements.

**Performance:** Similar to standard brass shim elements of similar size and thickness. Suitable for cryogenic and vacuum use. **Custom configurations,** sizes, and mounting options available. Maximum size: 2.65" (67.3mm) long x 2.65" (67.3mm) wide.

**ROHS:** Compliant. Piezo exempt.

#### PERFORMANCE: HIGH STRENGTH BENDING MOTORS (Cantilever Mount)

VALUES TO BE USED  
AS GUIDELINES

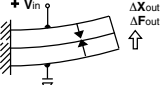
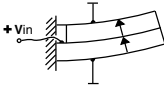
PART NUMBERS: HIGH STRENGTH BENDERS		WEIGHT (Grams)	STIFFNESS (N/m)	CAPACITANCE (nF) (Series Operation)	CAPACITANCE (nF) (Parallel Operation)	RATED VOLTAGE (Vp) (Series Operation)	RATED VOLTAGE (Vp) (Parallel Operation)	RESONANT FREQUENCY ① (Hz)	FREE DEFLECTION ① (µm)	BLOCKED FORCE ① (N)
										
X-poled for series bending operation (2 wire).		Y-poled for parallel bending operation (3 wire).								
<b>.015" (.38mm) THICK</b>										
T215-A4SS-103X	T215-A4SS-103Y	.30	1.3x10 <sup>2</sup>	5	20	± 120	± 60	270	± 300	± .04
T215-A4SS-203X	T215-A4SS-203Y	.60	2.7x10 <sup>2</sup>	10	40	± 120	± 60	270	± 300	± .08
T215-A4SS-303X	T215-A4SS-303Y	1.2	5.3x10 <sup>3</sup>	20	80	± 120	± 60	270	± 300	± .16
T215-A4SS-503X	T215-A4SS-503Y	6.0	1.6x10 <sup>2</sup>	100	400	± 120	± 60	67	± 1200	± .20
<b>.020" (.51mm) THICK</b>										
T220-A4SS-103X	T220-A4SS-103Y	.40	2.8x10 <sup>2</sup>	3.5	14	± 180	± 90	360	± 250	± .07
T220-A4SS-203X	T220-A4SS-203Y	.80	5.6x10 <sup>2</sup>	7	29	± 180	± 90	360	± 250	± .14
T220-A4SS-303X	T220-A4SS-303Y	1.6	1.1x10 <sup>3</sup>	15	58	± 180	± 90	360	± 250	± .28
T220-A4SS-503X	T220-A4SS-503Y	8.0	3.5x10 <sup>2</sup>	73	292	± 180	± 90	90	± 1000	± .35
<b>.026" (.66mm) THICK</b>										
T226-A4SS-103X	T226-A4SS-103Y	.51	0.7x10 <sup>3</sup>	2.5	10	± 250	± 125	440	± 175	± .13
T226-A4SS-203X	T226-A4SS-203Y	1.1	1.5x10 <sup>3</sup>	5	20	± 250	± 125	440	± 175	± .25
T226-A4SS-303X	T226-A4SS-303Y	2.1	3.0x10 <sup>3</sup>	10	40	± 250	± 125	440	± 175	± .50
T226-A4SS-503X	T226-A4SS-503Y	10.3	0.9x10 <sup>3</sup>	50	200	± 250	± 125	110	± 700	± .62

#### PRICE & ORDERING INFORMATION

1 pc    5    25    100

	X-POLED		Y-POLED		UNIT PRICE			
	Part No.	Part No.	Part No.	Part No.	1 pc	5	25	100
High Strength Bender, .015" T, -103 size	T215-A4SS-103X	T215-A4SS-103Y	T215-A4SS-103X	T215-A4SS-103Y	\$90	\$40	\$22	\$15
High Strength Bender, .015" T, -203 size	T215-A4SS-203X	T215-A4SS-203Y	T215-A4SS-203X	T215-A4SS-203Y	\$100	\$60	\$30	\$18
High Strength Bender, .015" T, -303 size	T215-A4SS-303X	T215-A4SS-303Y	T215-A4SS-303X	T215-A4SS-303Y	\$110	\$75	\$35	\$27
High Strength Bender, .015" T, -303 size	T215-A4SS-503X	T215-A4SS-503Y	T215-A4SS-503X	T215-A4SS-503Y	\$175	\$125	\$90	\$80
High Strength Bender, .020" T, -103 size	T220-A4SS-103X	T220-A4SS-103Y	T220-A4SS-103X	T220-A4SS-103Y	\$90	\$35	\$18	\$11
High Strength Bender, .020" T, -203 size	T220-A4SS-203X	T220-A4SS-203Y	T220-A4SS-203X	T220-A4SS-203Y	\$100	\$50	\$25	\$15
High Strength Bender, .020" T, -303 size	T220-A4SS-303X	T220-A4SS-303Y	T220-A4SS-303X	T220-A4SS-303Y	\$110	\$60	\$30	\$22
High Strength Bender, .020" T, -303 size	T220-A4SS-503X	T220-A4SS-503Y	T220-A4SS-503X	T220-A4SS-503Y	\$150	\$110	\$85	\$75
High Strength Bender, .026" T, -103 size	T226-A4SS-103X	T226-A4SS-103Y	T226-A4SS-103X	T226-A4SS-103Y	\$90	\$40	\$22	\$15
High Strength Bender, .026" T, -203 size	T226-A4SS-203X	T226-A4SS-203Y	T226-A4SS-203X	T226-A4SS-203Y	\$100	\$60	\$30	\$18
High Strength Bender, .026" T, -303 size	T226-A4SS-303X	T226-A4SS-303Y	T226-A4SS-303X	T226-A4SS-303Y	\$110	\$75	\$35	\$27
High Strength Bender, .026" T, -303 size	T226-A4SS-503X	T226-A4SS-503Y	T226-A4SS-503X	T226-A4SS-503Y	\$175	\$125	\$90	\$80

### QUICK-MOUNTED TRANSDUCERS PRE-MOUNTED AND WIRED, ONE END

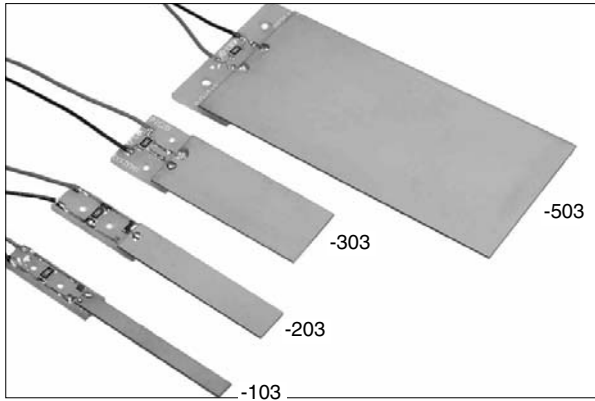

#### QUICK-MOUNT DESCRIPTION

Bending and extending transducers which are mounted, center accessed, and wired on one end are called **Quick-Mounts**. Their part numbers start with a Q. Quick-Mounts provide the following features:

- PCB mount on one end with 2 clearance holes for speedy installation.
- reuse in multiple tasks,
- accessed and wired for low voltage, parallel operation.
- 5" long lead wires.
- high resistance bleed resistor for protection of transducer and circuitry from mechanically and pyroelectrically generated voltages.

Pre-wired transducers with mounts on both ends are called **Double-Quick-Mounts**. They are discussed on pages 45-51.

**Sizes:** Quick-Mounts are sized to accommodate standard -103, -203, -303, and -503 size rectangular transducer elements. Custom size transducers may be mounted upon request.

**Standard Quick-Mounts:** Standard Quick-Mount benders and extenders (pages 40-43) are economically priced and stocked for immediate delivery. They use T220-A4-103, -203, -303, and -503 standard brass shim transducer elements.

**Custom Quick-Mounts:** Any 2-piezo layer transducer (see page 44) may be Quick-Mounted for use as a bender or extender. Generally, they are wired for parallel operation. However, when used as a generator (sensor) it may be desirable to wire them for series operation to increase the voltage output (at the expense of current output). **NOTE:** High Performance elements with a Quick-Mount are wired for series operation.

**Usage:** To avoid confusion, polarization (X or Y) and usage (bender or extender) are stated in the part numbers for Quick-Mounts. It should be noted that the same Quick-Mount can be used as either a motor (actuator) or a generator (sensor).

**Performance:** Because the active cantilever length of the Quick-Mount is fixed at 1.125" (for -103, -203, and -303 size) and 2.25" (for -503 size), their performance varies slightly from the respective performance tables for the 2-piezo layer transducer whose performance is based on 1.0" (for -103, -203, and -303 size) and 2.0" (for -503 size). Scale factors are provided on page 44.

**Example:** Q220-A4-503YB  
This is a T220-A4-503Y transducer, fitted with a Quick-Mount, to be used as a bender. It is a -503 size, made of PSI-5A4E piezoceramic, has a brass center shim, and is Y-poled for parallel bending operation. Its' overall dimensions are 2.75" long x 1.25" wide x ~.090" high.

QUICK-MOUNT PART NUMBERS				OPTIONS LISTED IN COLUMNS UNDER HEADINGS			
Q	2	20	- A4		- 503	Y	B
MOUNTING STYLES	NUMBER OF PIEZO LAYERS	THICKNESS DESIGNATION	PIEZOCERAMIC MATERIALS	REINFORCEMENT MATERIALS	STD. SIZE DESIGNATION	POLARIZATION	INTENDED USE
Q -Transducer with a Quick Mount	2	15 (.015") 16 (.016") 19 (.019") 20 (.020") 23 (.023") 26 (.026") 34 (.034")	-A4 PSI-5A4E -H4 PSI-5H4E  -A3 PSI-5A3	(blank) - Standard Brass Shim SS - High Strength Stainless Steel NM - Non-magnetic CL - High Performance NO - No shim	-103 -203 -303 -503	 X-Poled   Y-Poled	B Bender E Extender

**QUICK-MOUNT TRANSDUCERS**  
PRE-MOUNTED AND WIRED, ONE END

**QUICK-MOUNT DIMENSIONS**

**-103 Size Quick-Mount Dimensions**

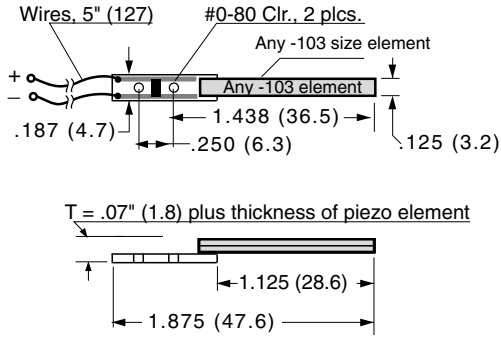

**-303 Size Quick-Mount Dimensions**

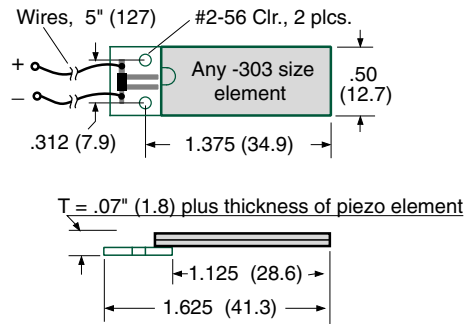

**-203 Size Quick-Mount Dimensions**

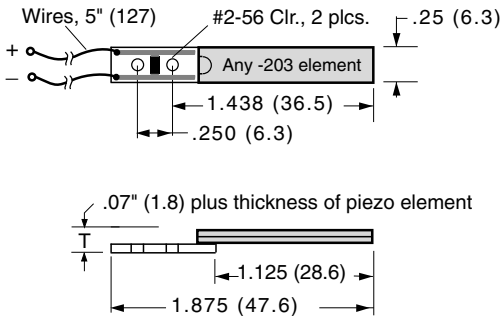

**-503 Size Quick-Mount Dimensions**

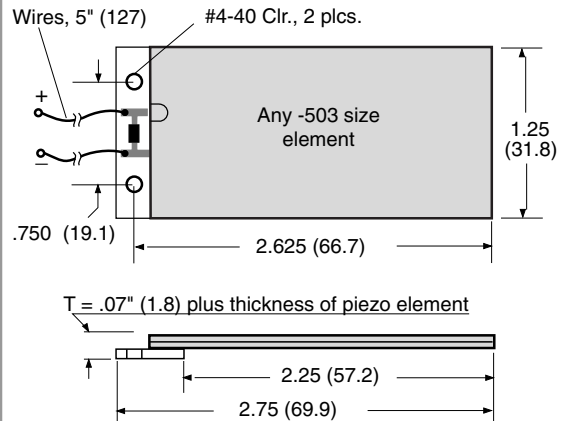

### STANDARD QUICK-MOUNT BENDING ACTUATOR PRE-MOUNTED AND WIRED, ONE END, ± 315 μm TO ± 1260 μm

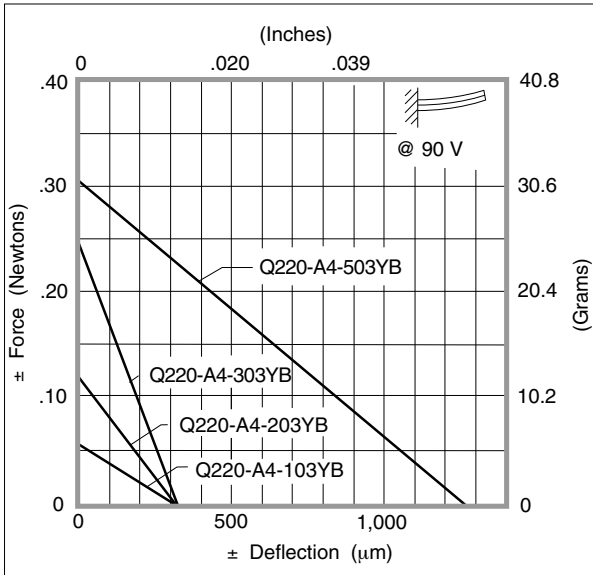
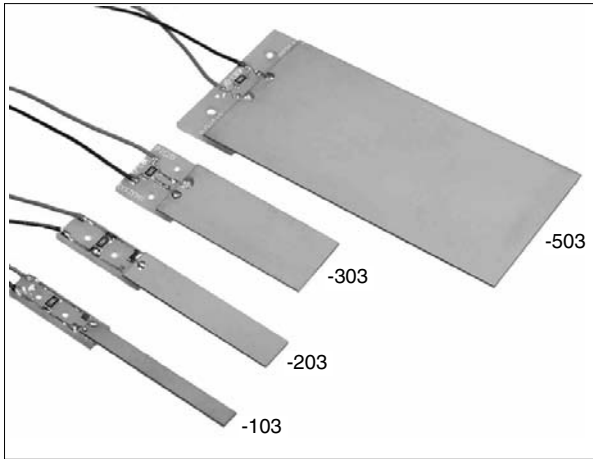

#### DESCRIPTION

**Bolt-down convenience on one end.** Standard Quick-Mount bending motors are easily attached to or removed from equipment using the two clearance holes in the PCB mount. They are wired for low voltage operation and the board mounted bleed resistor protects the transducer and user electronics from transient voltages arising from thermal and mechanical shocks. The user provides the mechanical connection between the transducer tip and their load.

Standard Quick-Mount Benders are more economically priced than other Quick-Mount configurations, and are generally stocked for immediate delivery.

Standard Quick-Mount Benders employ T220-A4-103Y, T220-A4-203Y, T220-A4-303Y or T220-A4-503Y standard brass reinforced transducers.

Dimensions for Standard Quick-Mounts are shown on [page 39](#).

Custom configurations and sizes: Upon request.

**ROHS: Compliant. Piezo exempt.**

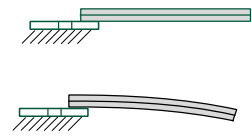

The tip of a Quick-Mount Bender moves in an arc.

#### PERFORMANCE: STANDARD QUICK-MOUNT BENDERS (Cantilever mode) VALUES TO BE USED AS GUIDELINES

PART NUMBER	PIEZO MATERIAL	WEIGHT	STIFFNESS	CAPACITANCE	MAXIMUM VOLTAGE	RESONANT FREQUENCY	FREE DEFLECTION	BLOCKED FORCE
		grams	N/m	nF	±Vp	Hz	±μm	±N
Q220-A4-103YB	5A4E	0.9	190	12	±90	275	± 315	± .06
Q220-A4-203YB	5A4E	1.4	380	26	±90	275	± 315	± .12
Q220-A4-303YB	5A4E	2.3	760	52	±90	275	± 315	± .24
Q220-A4-503YB	5A4E	9.5	245	260	±90	68	± 1260	± .31

#### PRICE & ORDERING INFORMATION

	PART NO.	1 pc	5	25	100
Standard Quick-Mount Bender, -103 Size	Q220-A4-103YB	\$179	\$99	\$59	\$49
Standard Quick-Mount Bender, -203 Size	Q220-A4-203YB	\$159	\$104	\$64	\$53
Standard Quick-Mount Bender, -303 Size	Q220-A4-303YB	\$179	\$114	\$74	\$62
Standard Quick-Mount Bender, -503 Size	Q220-A4-503YB	\$219	\$154	\$119	\$104



### STANDARD QUICK-MOUNT BENDING GENERATOR PRE-MOUNTED AND WIRED, ONE END

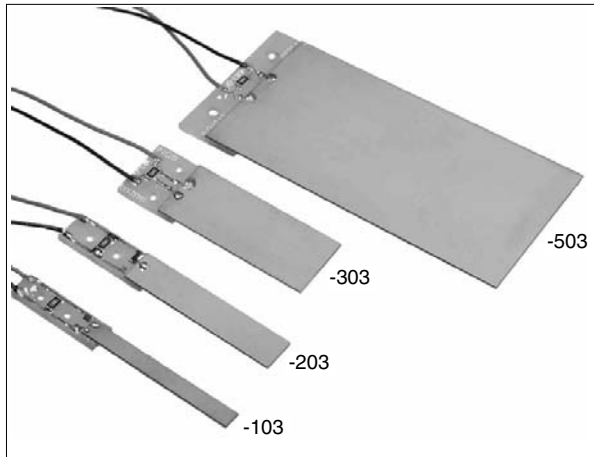

Quick-Mount bending sensors save users the trouble of mounting and wiring transducer elements. They are easily attached and removed from equipment using the two clearance holes in the PCB mounts. They are wired for parallel operation. The user may opt to remove the board mounted bleed resistor which protects the transducer and user electronics from transient voltages arising from thermal and mechanical shocks. The user provides the mechanical connection between the transducer tip and the mechanical source. Standard Quick-Mount Benders are more economically priced than other Quick-Mount configurations, and are generally stocked for immediate delivery.

Standard Quick-Mount Benders employ T220-A4-103Y, T220-A4-203Y, T220-A4-303Y or T220-A4-503Y standard brass reinforced transducers.

Dimensions for Standard Quick-Mounts are shown on [page 39](#).

Custom configurations and sizes: Upon request.

**ROHS:** Compliant. Piezo exempt.

#### DESCRIPTION

When a mechanical force causes a suitably wired and polarized 2-layer element to bend, one layer is compressed and the other is stretched. Charge develops across each layer in an effort to counteract the imposed strain. This charge may be collected for strain sensing or power generation.

#### PERFORMANCE: QUICK-MOUNT BENDING GENERATORS (Cantilever mount)

VALUES TO BE USED AS GUIDELINES

PART NUMBERS (QUICK-MOUNT BENDING GENERATORS)	PIEZO MATERIAL	WEIGHT (grams)	STIFFNESS (N/m)	CAPACITANCE (nF) (Parallel Operation)	RATED TIP DEFLECTION ① (mm <sub>peak</sub> )	RATED FREQUENCY ① (Hz)	OPEN CIRCUIT VOLTAGE ① At rated deflection, parallel operation (V <sub>peak</sub> )	CLOSED CIRCUIT CURRENT ① Per sinusoidal cycle, at rated deflection, parallel operation. (μA <sub>peak</sub> / Hz)	RATED OUTPUT POWER ① At rated deflection and frequency (mW <sub>rms</sub> )
Q220-A4-103YB	5A4E	0.9	1.9x10 <sup>2</sup>	12	± .38	250	± 16.5	± 2.2	1.1
Q220-A4-203YB	5A4E	1.4	3.8x10 <sup>2</sup>	26	± .38	250	± 16.5	± 4.4	2.3
Q220-A4-303YB	5A4E	2.3	7.6x10 <sup>2</sup>	52	± .38	250	± 16.5	± 8.8	4.5
Q220-A4-503YB	5A4E	9.5	2.4x10 <sup>2</sup>	260	± 1.57	45	± 18.1	± 46	4.7

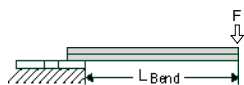

-103, -203, and -303 Quick-Mount generator performance is based on an active bending length of 1.125". -503 performance based on 2.25" active length. Quick-Mount performance is based on the force being applied at the outermost tip of the transducer

#### PRICE & ORDERING INFORMATION

PART NO.	1 pc	5	25	100	
Std QM Bending Generator, -103 Size	Q220-A4-103YB	\$179	\$99	\$59	\$49
Std QM Bending Generator, -203 Size	Q220-A4-203YB	\$159	\$104	\$64	\$53
Std QM Bending Generator, -303 Size	Q220-A4-303YB	\$179	\$114	\$74	\$62
Std QM Bending Generator, -503 Size	Q220-A4-503YB	\$219	\$154	\$119	\$104

### STANDARD QUICK-MOUNT EXTENSION ACTUATOR PRE-MOUNTED AND WIRED, ONE END, ± 3.6 μM TO ± 7.2 μM

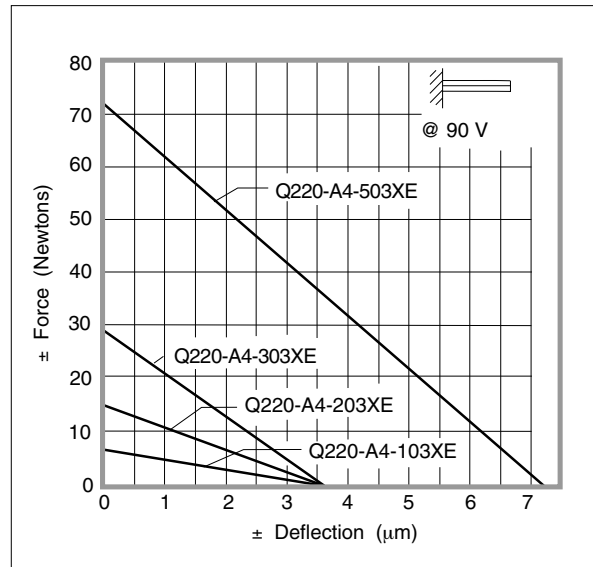
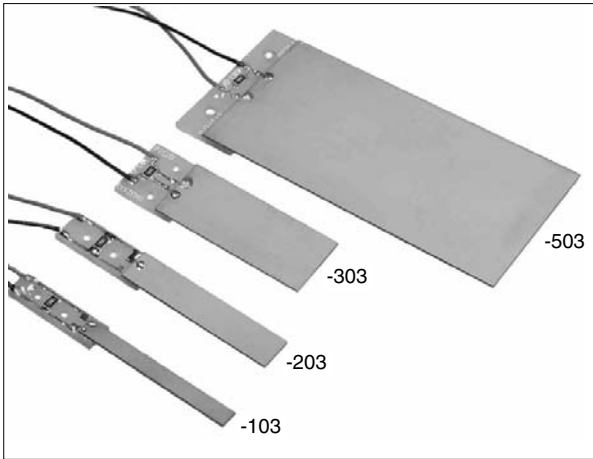

#### DESCRIPTION

**Bolt-down convenience on one end.** Standard Quick-Mount extension motors are easily attached to or removed from equipment using the two clearance holes in the PCB mount. They are wired for low voltage operation and the board mounted bleed resistor protects the transducer and user electronics from transient voltages arising from thermal and mechanical shocks. The user provides the mechanical connection between the transducer tip and their load.

Standard Quick-Mount Extenders are more economically priced than other Quick-Mount configurations and are generally stocked for immediate delivery.

Standard Quick-Mount Extenders employ T220-A4-103X, T220-A4-203X, T220-A4-303X or T220-A4-503X standard brass reinforced transducers.

Dimensions for Standard Quick-Mounts are shown on page 39.

Custom configurations and sizes: Upon request.

**ROHS: Compliant. Piezo exempt.**

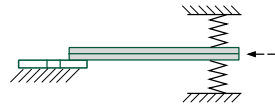

The tip of a Quick-Mount Extender moves longitudinally in the plane of the actuator. Constraining motion perpendicular to the plane is recommended to eliminate any residual bending motion and/or low frequency (bending and torsional) resonances.

#### PERFORMANCE: STANDARD QUICK-MOUNT EXTENSION MOTORS

VALUES TO BE USED AS GUIDELINES

PART NUMBER	PIEZO MATERIAL	WEIGHT	STIFFNESS	CAPACITANCE	MAXIMUM VOLTAGE	RESONANT FREQUENCY	FREE DEFLECTION	BLOCKED FORCE
		grams	N/m	nF	±Vp	Hz	±μm	±N
Q220-A4-103XE	5A4E	0.9	2x10 <sup>6</sup>	13	±90	26,200	± 3.6	± 7
Q220-A4-203XE	5A4E	1.4	4x10 <sup>6</sup>	26	±90	26,200	± 3.6	± 14
Q220-A4-303XE	5A4E	2.3	8x10 <sup>6</sup>	52	±90	26,200	± 3.6	± 29
Q220-A4-503XE	5A4E	9.4	10x10 <sup>6</sup>	254	±90	13,100	± 7.2	± 72

#### PRICE & ORDERING INFORMATION

#### PART NO.

1 pc

5

25

100

Standard Quick-Mount Extender, -103 Size  
 Standard Quick-Mount Extender, -203 Size  
 Standard Quick-Mount Extender, -303 Size  
 Standard Quick-Mount Extender, -503 Size

Q220-A4-103XE	\$179	\$99	\$59	\$49
Q220-A4-203XE	\$159	\$104	\$64	\$53
Q220-A4-303XE	\$179	\$114	\$74	\$62
Q220-A4-503XE	\$219	\$154	\$119	\$104

### STANDARD QUICK-MOUNT EXTENSION GENERATORS PRE-MOUNTED AND WIRED, ONE END

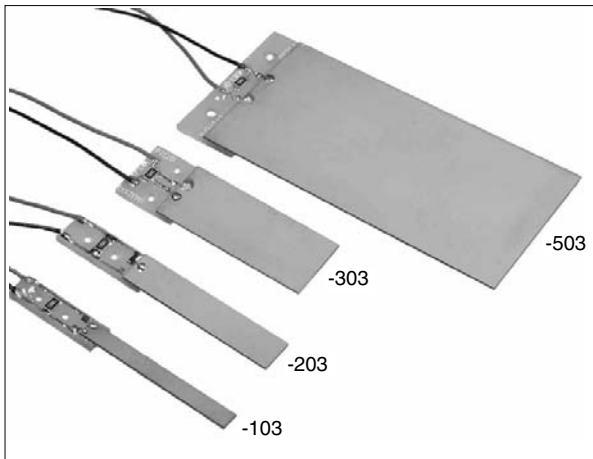

#### DESCRIPTION

When a mechanical force causes a suitably wired and polarized 2-layer element to extend (or contract), both layers are stretched (or compressed) at the same time. Charge develops across each layer in an effort to counteract the imposed strain. This charge may be collected for strain sensing or power generation.

Quick-Mount extension sensors save users the trouble of mounting and wiring transducer elements. They are easily attached and removed from equipment using the two clearance holes in the PCB mount. They are wired for parallel operation. The user may opt to remove the board mounted bleed resistor which protects the transducer and user electronics from transient voltages arising from thermal and mechanical shocks. The user provides the connection between the transducer tip and the mechanical source.

Standard Quick-Mount Extenders employ T220-A4-103X, T220-A4-203X, T220-A4-303X or T220-A4-503X standard brass reinforced transducers.

Standard Quick-Mount Extenders are more economically priced than other Quick-Mount configurations, and are generally stocked for immediate delivery.

Dimensions for Standard Quick-Mounts are shown on [page 39](#).

Custom configurations and sizes: Upon request.

**ROHS:** Compliant. Piezo exempt.

#### PERFORMANCE: QUICK-MOUNT EXTENSION GENERATORS (Cantilever mount)

VALUES TO BE USED AS GUIDELINES

PART NUMBERS (QUICK-MOUNT EXTENSION GENERATORS)	PIEZO MATERIAL	WEIGHT (grams)	STIFFNESS (N/m)	CAPACITANCE (nF) (Parallel Operation)	RATED TIP DEFLECTION ① ( $\mu\text{m}_{\text{peak}}$ )	RATED FREQUENCY ① (Hz)	OPEN CIRCUIT VOLTAGE ① At rated deflection, parallel operation (V <sub>peak</sub> )	CLOSED CIRCUIT CURRENT ① Per sinusoidal cycle, at rated deflection, parallel operation. ( $\mu\text{A}_{\text{peak}}$ / Hz)	RATED OUTPUT POWER ① At rated deflection and frequency (mW <sub>rms</sub> )
Q220-A4-103XE	5A4E	0.9	$2 \times 10^6$	13	$\pm 14.5$	1500	$\pm 73$	$\pm 6$	80
Q220-A4-203XE	5A4E	1.4	$4 \times 10^6$	26	$\pm 14.5$	1500	$\pm 73$	$\pm 12$	170
Q220-A4-303XE	5A4E	2.3	$8 \times 10^6$	52	$\pm 14.5$	1500	$\pm 73$	$\pm 24$	330
Q220-A4-503XE	5A4E	9.5	$10 \times 10^6$	260	$\pm 28$	750	$\pm 73$	$\pm 119$	810

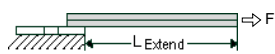

-103, -203, and -303 Quick-Mount extension generator performance is based on an active extension length of 1.125". -503 performance is based on 2.25" active length. Quick-Mount performance is based on the force being applied at the outermost tip of the transducer.

#### PRICE & ORDERING INFORMATION

PART NO.	1 pc	5	25	100	
Std QM Extension Generator, -103 Size	Q220-A4-103XE	\$179	\$99	\$59	\$49
Std QM Extension Generator, -203 Size	Q220-A4-203XE	\$159	\$104	\$64	\$53
Std QM Extension Generator, -303 Size	Q220-A4-303XE	\$179	\$114	\$74	\$62
Std QM Extension Generator, -503 Size	Q220-A4-503XE	\$219	\$154	\$119	\$104

### ADDING A QUICK-MOUNT TO ANY -103, -203, -303, AND -503 TRANSDUCERS

#### PERFORMANCE SCALE FACTORS

**Quick-Mount Performance:** The cantilever length of a Quick Mounted element is slightly longer than the cantilever length of its associated transducer element. To derive its performance from its associated transducer element, perform the operation indicated below. For example, to find the free deflection of a Q219-A4CL-503XB Quick-Mount bender, multiply the free deflection of the T219-A4CL-503X bending motor by 1.26 (i.e.  $\pm 1,220 \mu\text{m} \times 1.26 = \pm 1,537 \mu\text{m}$ ).

The performance of a custom Quick Mount varies slightly from the listed performance of its associated <b>transducer</b> because of a slightly longer cantilever length.			QUICK MOUNT BENDERS						QUICK MOUNT EXTENDERS				
			WEIGHT (GRAMS)	CAPACITANCE (nF) (Parallel Operation)	RATED VOLTAGE (Vp) (Parallel Operation)	STIFFNESS (N/m)	RESONANT FREQUENCY (Hz)	FREE DEFLECTION ( $\mu\text{m}$ )	BLOCKED FORCE (N)	STIFFNESS (N/m)	RESONANT FREQUENCY (Hz)	FREE DEFLECTION ( $\mu\text{m}$ )	BLOCKED FORCE (N)
Cantilever Length, Inches (mm)													
Size	Transducer Elements	Quick Mounts											
-103	1.00 (25.4)	1.125 (28.6)											
-203	1.00 (25.4)	1.125 (28.6)											
-303	1.00 (25.4)	1.125 (28.6)											
-503	2.00 (25.4)	2.250 (28.6)											
			+0.4	x.9	x1	x.7	x.79	x1.26	x.89	x.89	x.89	x1.12	x1
			+0.6	x.9	x1	x.7	x.79	x1.26	x.89	x.89	x.89	x1.12	x1
			+0.7	x.9	x1	x.7	x.79	x1.26	x.89	x.89	x.89	x1.12	x1
			+1.4	x.9	x1	x.7	x.79	x1.26	x.89	x.89	x.89	x1.12	x1

To determine the price of adding a Quick-Mount to any -103, -203, -303, or -503 transducer, add the price of the Quick Mount to the price of the transducer. For example, the unit price for 25 pieces of a Q223-A4CL-303XB (High Performance Quick-Mount Bender) would be \$35 (transducer) + \$59 (Quick Mount) = \$94 each.

ORDERING INFO		1 pc.	5	25	100		
PRICE OF TRANSDUCER	+	PRICE OF ADDING A QUICK-MOUNT				=	PRICE OF QUICK-MOUNTED TRANSDUCER
Any -103 size Transducer		\$99	\$74	\$54	\$44	-103 size Quick Mount	
Any -203 size Transducer		\$99	\$74	\$54	\$44	-203 size Quick Mount	
Any -303 size Transducer		\$109	\$79	\$59	\$49	-303 size Quick Mount	
Any -503 size Transducer		\$119	\$84	\$64	\$54	-503 size Quick Mount	

### DOUBLE-QUICK-MOUNTED TRANSDUCERS PRE-MOUNTED & WIRED, TWO ENDS

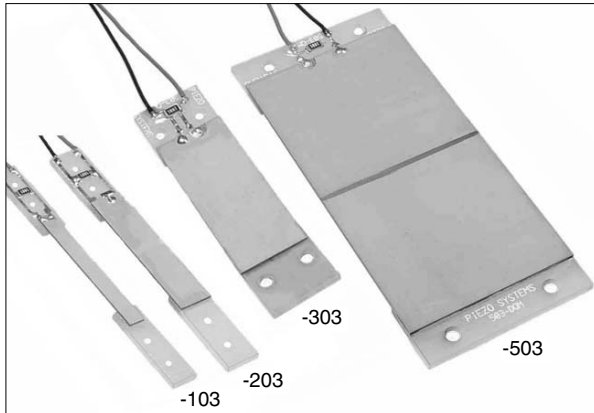

#### PART NUMBERS

Bending and extending transducers which are pre-wired and have mounts on both ends, and are called Double-Quick-Mounts. Their part numbers start with a D. Double-Quick-Mounts provide the following features:

- PCB mounts on both ends with 2 clearance holes in each for speedy installation,
- reuse in multiple tasks,
- accessed and wired for low voltage (parallel operation),
- 5" long lead wires, and
- high resistance bleed resistor for protection of transducer and circuitry from mechanically and pyroelectrically generated voltages.

Transducers which are pre-wired and mounted on one end are called Quick-Mounts and are discussed on [pages 38-44](#).

Sizes: Double-Quick-Mounts are sized to accommodate standard -103, -203, -303, and -503 size rectangular trans-

ducer elements. Custom size elements may be mounted upon request.

Standard Double-Quick-Mounts: Standard Double Quick-Mounts ([pages 47-50](#)) are economically priced and stocked for quick delivery. They use T220-A4-103, -203, -303, and -503 transducer elements.

Custom Double-Quick-Mounts: Any 2-piezo layer transducer may be Double-Quick mounted for use as a bender or extender (see [page 51](#)). Generally, they are wired for parallel operation. However, when used as a generator (sensor) it may be desirable to wire them for series operation to increase the voltage output (at the expense of current output). NOTE: High Performance elements with a Double Quick-Mount are only wired for series operation.

Usage: To avoid confusion, polarization (X or Y) and usage (bender or extender) are stated in the part numbers for Double-Quick-Mounts. It should be noted that the same Double Quick-Mount can be used as either a motor (actuator) or a generator (sensor).

Performance: Performance of the Double-Quick-Mount is measured at the tip of the PCB. Longer cantilever length and additional tip mass alters their performance from that listed for their associated transducers. Approximate scale factors are provided on [page 51](#).

Part number construction: D220-A4-503XE

This is a T220-A4-503X transducer, fitted with a Double Quick-Mount, being used as an extender. It has a -503 size transducer, .020" thick, made of PSI-5A4E piezoceramic with a brass center shim, and is X-poled for parallel extension operation. The overall dimensions of the actuator are 3.00" long, 1.25" wide, and ~.01" high.

#### DOUBLE-QUICK-MOUNT PART NUMBERS

OPTIONS LISTED IN COLUMNS UNDER HEADINGS

D	2	20	-	A4		-	503	X	E
MOUNTING STYLES	NUMBER OF PIEZO LAYERS	THICKNESS DESIGNATION		PIEZOCERAMIC MATERIALS	REINFORCEMENT MATERIALS		SIZE DESIGNATION	POLARIZATION	INTENDED USE
D -Transducer with a Double Quick Mount	2	15 (.015")		-A4 PSI-5A4E	(blank) - Standard		-103	 X-Poled	B Bender E Extender
		16 (.016")		-H4 PSI-5H4E	Brass Shim	-203			
		19 (.019")			SS - High Strength	-303			
		20 (.020")			Stainless Steel	-503			
		23 (.023")			NM - Non-magnetic				
		26 (.026")			CL - High Performance				
34 (.034")			NO - No shim			 Y-Poled			

### DOUBLE-QUICK-MOUNT TRANSDUCERS PRE-MOUNTED & WIRED, TWO ENDS

#### STANDARD DOUBLE-QUICK-MOUNT DIMENSIONS

##### -103 Double-Quick-Mount Dimensions

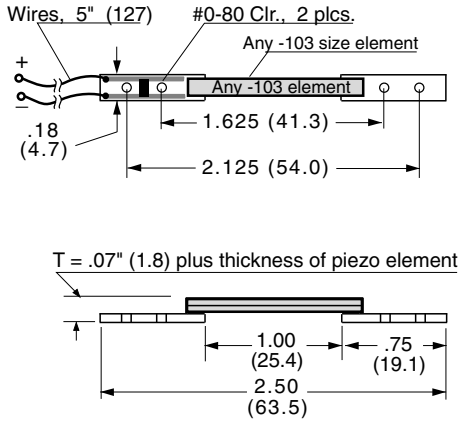

##### -303 Double-Quick-Mount Dimensions

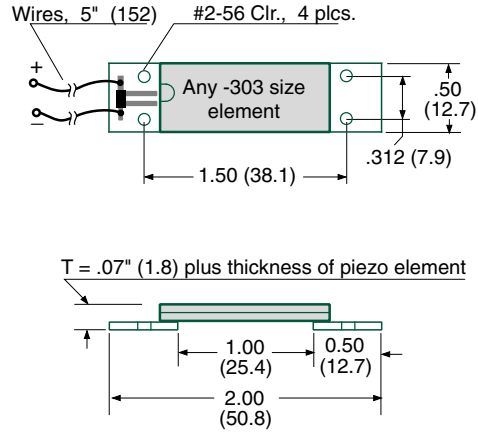

##### -203 Double-Quick-Mount Dimensions

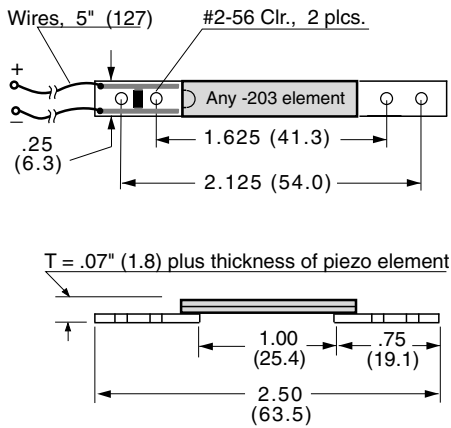

##### -503 Double-Quick-Mount Dimensions

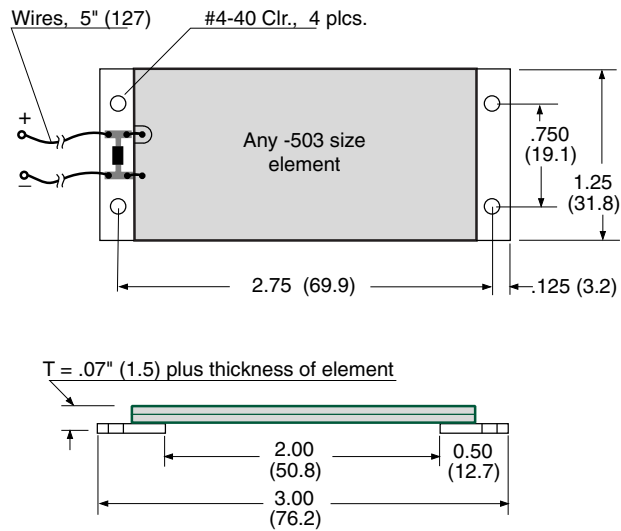



### STD. DOUBLE-QUICK-MOUNT BENDING MOTORS PRE-MOUNTED AND WIRED, TWO ENDS, ± 570 μm TO ± 1600 μm

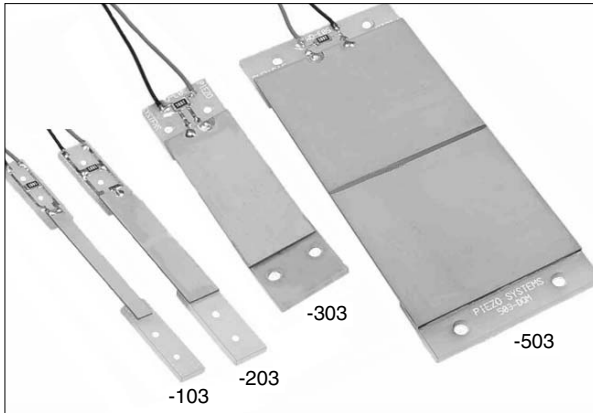

#### DESCRIPTION

##### Bolt-down convenience on two ends.

Standard Double-Quick-Mount bending motors attach easily to equipment using the PCB mounting holes. They are wired for low voltage operation and the board mounted bleed resistor protects the transducer and user electronics from transient voltages arising from thermal and mechanical shocks. They possess very low magnetic permeability, and generate no significant magnetic field. Standard Double-Quick-Mount Benders employ T220-A4-103Y, T220-A4-203Y, T220-A4-303Y or T220-A4-503Y transducers.

Dimensions for Standard Double-Quick-Mount are shown on [page 46](#).

Custom configurations and sizes: Upon request.

**ROHS: Compliant. Piezo exempt.**

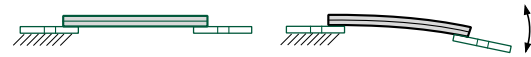
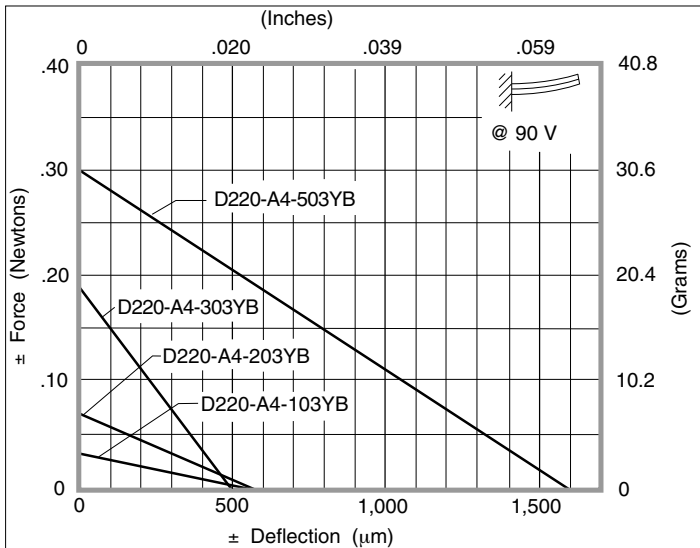

The tip of a cantilevered bender moves in an arc.

#### PERFORMANCE: STD DOUBLE-QUICK-MOUNT BENDING MOTORS

VALUES TO BE USED AS GUIDELINES

PART NUMBER	PIEZO MATERIAL	WEIGHT	STIFFNESS	CAPACITANCE	RATED VOLTAGE	RESONANT FREQUENCY	FREE DEFLECTION	BLOCKED FORCE
		grams	N/m	nF	±Vp	Hz	±μm	±N
D220-A4-103YB	5A4E	1.1	61	12	± 90	110	± 570	± .03
D220-A4-203YB	5A4E	1.7	123	23	± 90	130	± 570	± .07
D220-A4-303YB	5A4E	2.7	364	46	± 90	160	± 495	± .18
D220-A4-503YB	5A4E	10.4	188	232	± 90	52	± 1,600	± .30

#### ORDERING INFORMATION

	PART NO.	1 pc.	5	25	100
Standard Double-QM Bending Motor -103 size	D220-A4-103YB	\$184	\$104	\$69	\$53
Standard Double-QM Bending Motor -203 size	D220-A4-203YB	\$189	\$114	\$74	\$56
Standard Double-QM Bending Motor -303 size	D220-A4-303YB	\$209	\$134	\$84	\$67
Standard Double-QM Bending Motor -503 size	D220-A4-503YB	\$249	\$179	\$134	\$109

### STD. DOUBLE-QUICK-MOUNT BENDING GENERATORS PRE-MOUNTED AND WIRED, TWO ENDS

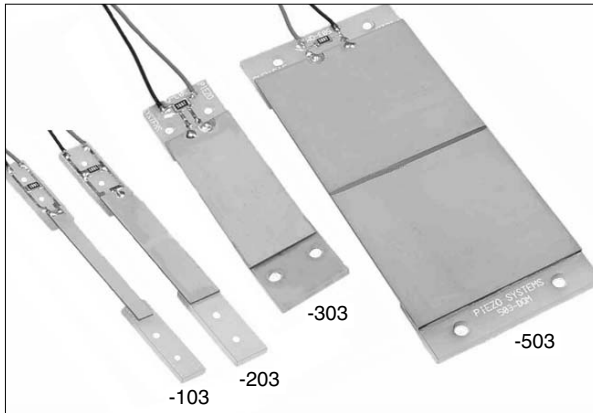

Double Quick-Mount bending sensors save users the trouble of mounting and wiring transducer elements. They are easily attached and removed from equipment using the two clearance holes in the PCB mount. They are wired for parallel operation. The user may opt to remove the board mounted bleed resistor which protects the transducer and user electronics from transient voltages arising from thermal and mechanical shocks. The user mounts the transducer to the source of mechanical strain.

Standard Double Quick-Mount Benders employ T220-A4-103X, T220-A4-203X, T220-A4-303X or T220-A4-503X standard brass reinforced transducers.

Standard Double Quick-Mount Benders are more economically priced than other Double Quick-Mount configurations, and are generally stocked for immediate delivery.

Dimensions for Standard Double-Quick-Mounts are shown on [page 46](#).

Custom configurations and sizes: Upon request.

**ROHS: Compliant. Piezo exempt.**

#### DESCRIPTION

When a mechanical force causes a suitably wired and polarized 2-layer element to bend, one layer is compressed and the other is stretched. Charge develops across each layer in an effort to counteract the imposed strain. This charge may be collected for strain sensing or power generation.

#### PERFORMANCE: DOUBLE QUICK-MOUNT BENDING GENERATORS (Cantilever mount)

VALUES TO BE USED AS GUIDELINES

PART NUMBERS DOUBLE QUICK-MOUNT BENDING GENERATORS	PIEZO MATERIAL	WEIGHT (grams)	STIFFNESS (N/m)	CAPACITANCE (nF) (Parallel Operation)	RATED TIP DEFLECTION ① (mm <sub>peak</sub> )	RATED FREQUENCY ① (Hz)	OPEN CIRCUIT VOLTAGE ① At rated deflection, parallel operation (V <sub>peak</sub> )	CLOSED CIRCUIT CURRENT ① Per sinusoidal cycle, at rated deflection, parallel operation. (μA <sub>peak</sub> / Hz)	RATED OUTPUT POWER ① At rated deflection and frequency (mW <sub>rms</sub> )
D220-A4-103YB	5A4E	1.1	6.1×10 <sup>1</sup>	12	± 1.0	100	± 14.9	± 2.0	.37
D220-A4-203YB	5A4E	1.7	1.2×10 <sup>2</sup>	23	± 1.0	120	± 14.9	± 3.9	.88
D220-A4-303YB	5A4E	2.7	3.6×10 <sup>2</sup>	46	± .84	145	± 14.9	± 7.9	2.1
D220-A4-503YB	5A4E	10.4	1.9×10 <sup>2</sup>	232	± 2.6	47	± 20.9	± 52	6.4

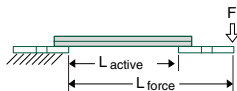

-103, -203, and -303 Double Quick-Mount bending generator performance is based on an active extension length of 1.0". -503 performance based on 2.0" active length. Double Quick-Mount performance is based on the force being applied at the outermost tip of the mount.

PRICE & ORDERING INFORMATION		PART NO.	1 pc	5	25	100
Std Double QM Bending Generator,	-103 Size	D220-A4-103YB	\$184	\$104	\$69	\$53
Std Double QM Bending Generator,	-203 Size	D220-A4-203YB	\$189	\$114	\$74	\$56
Std Double QM Bending Generator,	-303 Size	D220-A4-303YB	\$209	\$134	\$84	\$67
Std Double QM Bending Generator,	-503 Size	D220-A4-503YB	\$249	\$179	\$134	\$109



### STD. DOUBLE-QUICK-MOUNT EXTENSION MOTORS PRE-MOUNTED AND WIRED, TWO END, ± 3.6 μm TO ± 7.2 μm

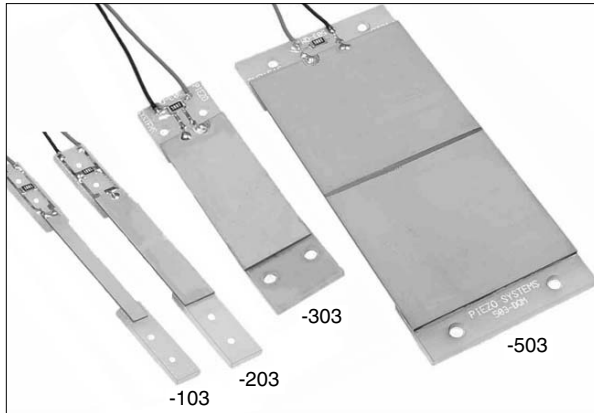

#### DESCRIPTION

##### Bolt-down convenience on two ends.

Standard Double-Quick-Mount Extenders attach easily to equipment using the PCB mounting holes, and may be used to produce bending or extension. They are wired for low voltage operation and the board mounted bleed resistor protects the transducer and user electronics from transient voltages arising from thermal and mechanical shocks. They possess very low magnetic permeability, and generate no significant magnetic field. Standard Double-Quick-Mount extenders employ T220-A4-103X, T220-A4-203X, T220-A4-303X or T220-A4-503X transducers.

Dimensions for Standard Double-Quick-Mounts are shown on [page 46](#).

Custom configurations and sizes: Upon request.

**ROHS:** Compliant. Piezo exempt.

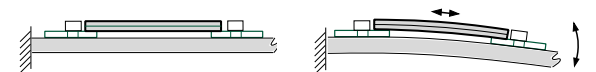
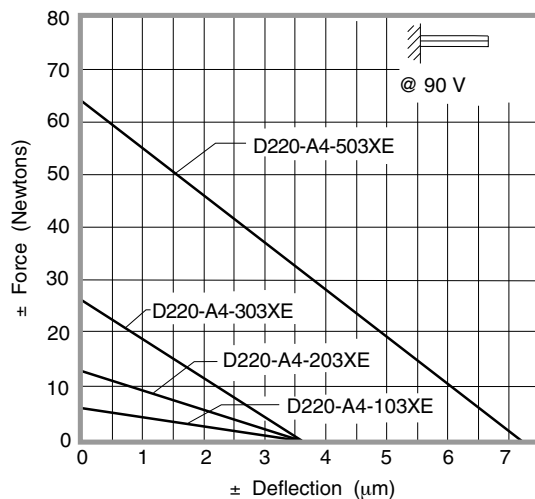

Extension element used to produce bending motion.

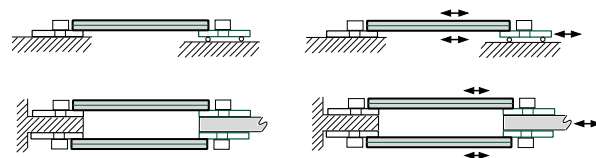

Extension element used to produce linear motion.

#### PERFORMANCE: STD DOUBLE-QUICK-MOUNT EXTENSION MOTOR

VALUES TO BE USED AS GUIDELINES

PART NUMBER	PIEZO MATERIAL	WEIGHT grams	STIFFNESS N/m	CAPACITANCE nF	RATED VOLTAGE ±Vp	RESONANT FREQUENCY Hz	FREE DEFLECTION ±μm	BLOCKED FORCE ±N
D220-A4-103XE	5A4E	1.1	2×10 <sup>6</sup>	13	± 90	24,000	± 3.6	± 6
D220-A4-203XE	5A4E	1.7	3×10 <sup>6</sup>	28	± 90	24,500	± 3.6	± 12
D220-A4-303XE	5A4E	2.7	7×10 <sup>6</sup>	52	± 90	25,000	± 3.6	± 26
D220-A4-503XE	5A4E	10.4	8×10 <sup>6</sup>	255	± 90	12,000	± 7.2	± 64

#### ORDERING INFORMATION

#### PART NO.

1 pc.

5

25

100

Standard Double-QM Extension Motor	-103 size	D220-A4-103XE	\$184	\$104	\$69	\$53
Standard Double-QM Extension Motor	-203 size	D220-A4-203XE	\$189	\$114	\$74	\$56
Standard Double-QM Extension Motor	-303 size	D220-A4-303XE	\$209	\$134	\$84	\$67
Standard Double-QM Extension Motor	-503 size	D220-A4-503XE	\$249	\$179	\$134	\$109

### STD. DOUBLE-QUICK-MOUNT EXTENSION GENERATORS PRE-MOUNTED AND WIRED, TWO ENDS

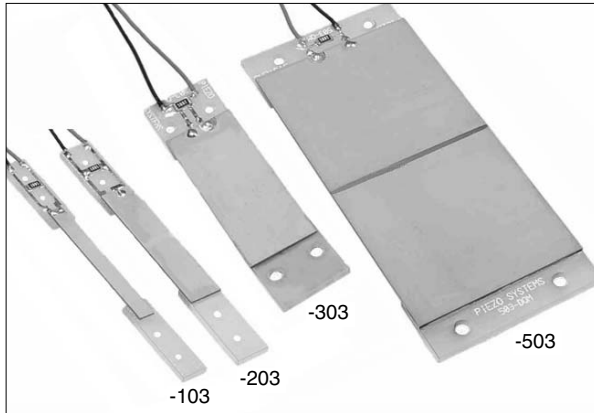

Double Quick-Mount extension sensors save users the trouble of mounting and wiring transducer elements. They are easily attached and removed from equipment using the two clearance holes in the PCB mounts. They are wired for parallel operation. The user may opt to remove the board mounted bleed resistor which protects the transducer and user electronics from transient voltages arising from thermal and mechanical shocks. The user mounts the transducer to the source of mechanical strain.

Standard Double Quick-Mount Extenders are more economically priced than other Double Quick-Mount configurations, and are generally stocked for immediate delivery.

Standard Double Quick-Mount Extenders employ T220-A4-103X, T220-A4-203X, T220-A4-303X or T220-A4-503X standard brass reinforced transducers.

Dimensions for Standard Double-Quick-Mounts are shown on [page 46](#).

Custom configurations and sizes: Upon request.

**ROHS:** Compliant. Piezo exempt.

#### DESCRIPTION

When a mechanical force causes a suitably wired and polarized 2-layer element to extend (or contract), both layers are stretched (or compressed) at the same time. Charge develops across each layer in an effort to counteract the imposed strain. This charge may be collected for strain sensing or power generation.

#### PERFORMANCE: DOUBLE QUICK-MOUNT EXTENSION GENERATORS (Cantilever)

VALUES TO BE USED AS GUIDELINES

PART NUMBERS DOUBLE QUICK-MOUNT EXTENSION GENERATORS	PIEZO MATERIAL	WEIGHT (grams)	STIFFNESS (N/m)	CAPACITANCE (nF) (Parallel Operation)	RATED TIP DEFLECTION ① ( $\mu\text{m}_{\text{peak}}$ )	RATED FREQUENCY ① (Hz)	OPEN CIRCUIT VOLTAGE ① At rated deflection, parallel operation (V <sub>peak</sub> )	CLOSED CIRCUIT CURRENT ① Per sinusoidal cycle, at rated deflection, parallel operation. ( $\mu\text{A}_{\text{peak}}$ / Hz)	RATED OUTPUT POWER ① At rated deflection and frequency (mW <sub>rms</sub> )
D220-A4-103XE	5A4E	1.1	$2 \times 10^6$	12	$\pm 13$	1500	$\pm 64$	$\pm 5$	60
D220-A4-203XE	5A4E	1.7	$3 \times 10^6$	26	$\pm 13$	1500	$\pm 64$	$\pm 10$	120
D220-A4-303XE	5A4E	2.7	$7 \times 10^6$	52	$\pm 13$	1500	$\pm 64$	$\pm 21$	240
D220-A4-503XE	5A4E	10.4	$8 \times 10^6$	260	$\pm 25$	750	$\pm 64$	$\pm 105$	630



-103, -203, and -303 Double Quick-Mount extension generator performance is based on an active extension length of 1.0". -503 performance based on 2.0" active length. Double Quick-Mount performance is based on the force being applied at the outermost tip of the mount.

PRICE & ORDERING INFORMATION	PART NO.	1 pc	5	25	100
Std Double QM Extension Generator, -103 Size	D220-A4-103XE	\$184	\$104	\$69	\$53
Std Double QM Extension Generator, -203 Size	D220-A4-203XE	\$189	\$114	\$74	\$56
Std Double QM Extension Generator, -303 Size	D220-A4-303XE	\$209	\$134	\$84	\$67
Std Double QM Extension Generator, -503 Size	D220-A4-503XE	\$249	\$179	\$134	\$109

# ADDING A DOUBLE-QUICK-MOUNT TO OTHER -103, -203, -303, AND -503 SIZE TRANSDUCERS

## PERFORMANCE SCALE FACTORS

**Double-Quick-Mount Performance:** To derive of the performance of a Double-Quick-Mount (due to its longer cantilever length and added tip mass) from the performance of its associated transducer, perform the operation indicated below. For example, to find the free deflection of a D219-A4CL-503XB Quick-Mount bender, multiply the free deflection of the T219-A4CL-503X bending motor (page 34) by 1.5 (i.e.  $\pm 1,220 \mu\text{m} \times 1.5 = \pm 1,830 \mu\text{m}$ ).

	VALUES TO BE USED AS GUIDELINES			DOUBLE-QUICK BENDERS				DOUBLE-QUICK EXTENDERS			
	WEIGHT (GRAMS)	CAPACITANCE (nF) (Parallel Operation)	RATED VOLTAGE (Vp) (Parallel Operation)	STIFFNESS (N/m)	RESONANT FREQUENCY (Hz)	FREE DEFLECTION ( $\mu\text{m}$ )	BLOCKED FORCE (N)	STIFFNESS (N/m)	RESONANT FREQUENCY (Hz)	FREE DEFLECTION ( $\mu\text{m}$ )	BLOCKED FORCE (N)
	+0.7	x 1.0	x 1	x .24	x .34	x 2.4	x .57	x .9	x .8	x 1.1	x 1
	+0.9	x .95	x 1	x .24	x .40	x 2.4	x .57	x .9	x .82	x 1.1	x 1
	+1.1	x .90	x 1	x .36	x .46	x 2.0	x .71	x .9	x .85	x 1.1	x 1
	+2.3	x .85	x 1	x .57	x .62	x 1.5	x .86	x .9	x .8	x 1.1	x 1

To determine the price of any -103, -203, -303, or -503 Double-Quick-Mount, add the price of the transducer to the additional price of the Double-Quick Mount. For example, the price for 25 pieces of a D223-A4CL-303XB would be \$35 (transducer) + \$69 (Double-Quick Mount) = \$104 each.

ORDERING INFO	1 pc.	5	25	100		
PRICE OF TRANSDUCER +	PRICE OF ADDING A DOUBLE-QUICK MOUNT				=	PRICE OF DOUBLE-QUICK MOUNTED TRANSDUCER
Any -103 size Transducer	\$129	\$89	\$64	\$49	-103 Double Quick Mount	
Any -203 size Transducer	\$129	\$89	\$64	\$49	-203 Double Quick Mount	
Any -303 size Transducer	\$139	\$99	\$69	\$54	-303 Double Quick Mount	
Any -503 size Transducer	\$149	\$109	\$79	\$59	-503 Double Quick Mount	

### 2-LAYER PIEZO BENDING DISKS

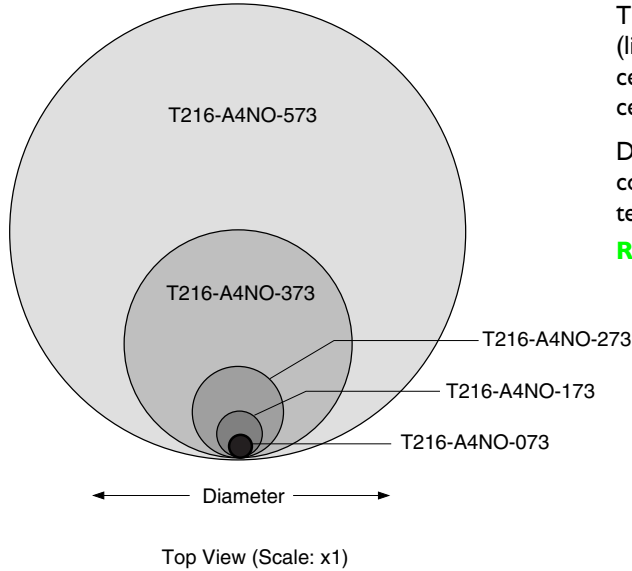

#### DESCRIPTION

The T216-A4NO Bending Disk elements bow in and out (like a drum head) when actuated. Because they have no center shim reinforcement, they are not intended to be center accessed.

Disks are stocked for “off-the-shelf” delivery. Custom configurations and sizes upon request. Maximum diameter is 2.75” (69.8mm).

**ROHS: Compliant. Piezo exempt.**

PART NUMBER	DIAMETER	
	Inches	(mm)
Elements made with PSI-5A4E Piezoceramic		
T216-A4NO-073X	.125	(3.2)
T216-A4NO-173X	.250	(6.4)
T216-A4NO-273X	.500	(12.7)
T216-A4NO-373X	1.250	(31.8)
T216-A4NO-573X	2.500	(63.5)

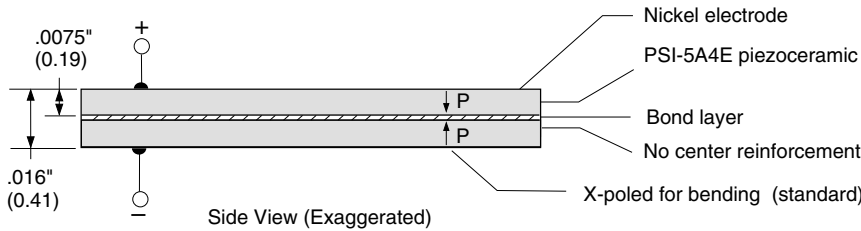

#### SELECTION CHART: BENDING DISK MOTOR

VALUES TO BE USED AS GUIDELINES

PART NUMBERS (BENDING DISKS)	WEIGHT (Grams)	STIFFNESS (N/m)	CAPACITANCE (nF) (Series Operation)	RATED VOLTAGE (Vp) (Series Operation)	RESONANT FREQUENCY ① (Hz)	FREE DEFLECTION ① (µm)	BLOCKED FORCE ① (N)	① Performance based on full diameter bending length.				
	<b>ORDERING INFORMATION</b>											
	1 pc.    5    25    100											
	UNIT PRICE											
	<b>.016" (.41mm) THICK</b>											
	T216-A4NO-073X	.03	2x10 <sup>4</sup>	0.3	± 180	116,000	± 1.2	± 2.4	\$60	\$40	\$20	\$6
T216-A4NO-173X	.10	500x10 <sup>3</sup>	1.1	± 180	29,300	± 4.7	± 2.4	\$75	\$45	\$25	\$10	
T216-A4NO-273X	.40	125x10 <sup>3</sup>	4.3	± 180	7,300	± 19.1	± 2.4	\$100	\$60	\$35	\$18	
T216-A4NO-373X	2.5	20x10 <sup>3</sup>	27	± 180	1,170	± 119	± 2.4	\$150	\$115	\$60	\$45	
T216-A4NO-573X	9.8	5x10 <sup>3</sup>	107	± 180	290	± 476	± 2.4	\$225	\$190	\$150	\$130	

### STANDARD 4-LAYER ELEMENTS USED AS BENDING MOTORS, $\pm 262 \mu\text{m}$ VERSION & $\pm 1,050 \mu\text{m}$ VERSION

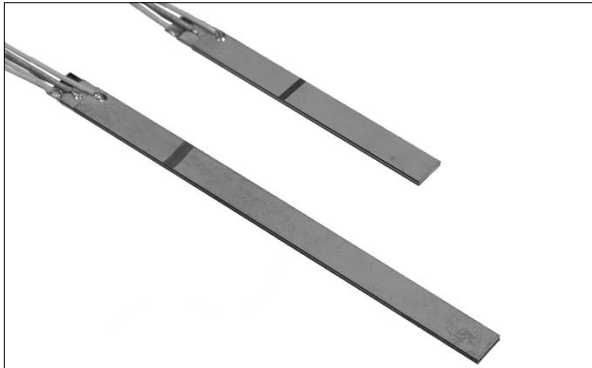

#### DESCRIPTION

The 4-Layer Bending Elements deliver a relatively high motion and force in a small package. Their low magnetic permeability allows them to be used in many applications requiring non-magnetic actuators.

“Off-the-shelf” delivery. Custom configurations and sizes upon request.

**ROHS:** Compliant. Piezo exempt.

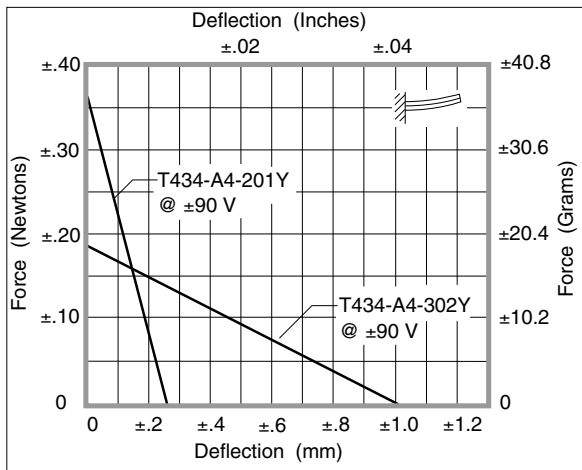

#### DIMENSIONS

##### T434-A4-201 Dimensions

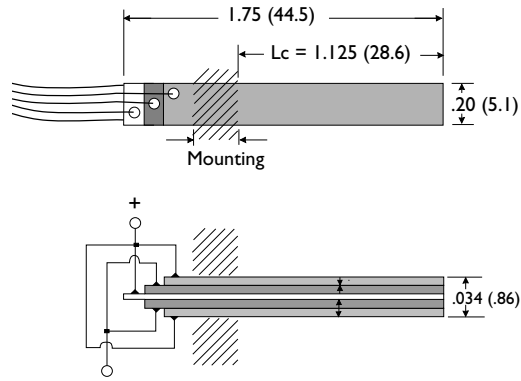

##### T434-A4-302 Dimensions

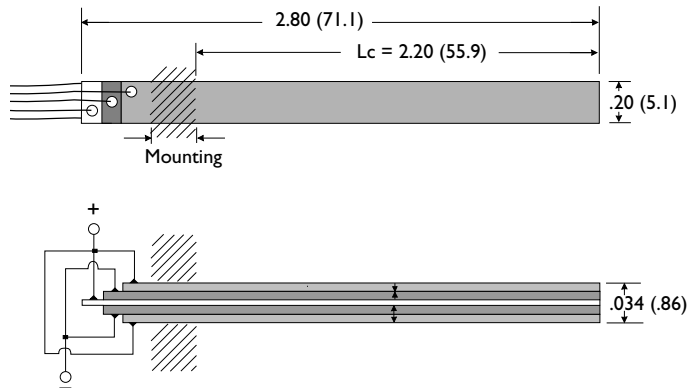

#### PERFORMANCE: 4-LAYER BENDER (Cantilever length, $L_c$ , shown above)

VALUES TO BE USED AS GUIDELINES

PART NUMBER	PIEZO MATERIAL	WEIGHT	STIFFNESS	CAPACITANCE	MAXIMUM VOLTAGE	RESONANT FREQUENCY	FREE DEFLECTION	BLOCKED FORCE
		grams	N/m	nF	$\pm V_p$	Hz	$\pm \mu\text{m}$	$\pm \text{N}$
T434-A4-201	5A4E	1.8	$1.4 \times 10^3$	77	$\pm 90$	440	$\pm 262$	$\pm .36$
T434-A4-302	5A4E	2.6	$1.8 \times 10^2$	110	$\pm 90$	112	$\pm 1,000$	$\pm .18$

#### ORDERING INFORMATION

4-Layer Bending Element,  $\pm 262 \mu\text{m}$   
4-Layer Bending Element,  $\pm 1,050 \mu\text{m}$

#### PART NO.    1 pc.    5 pc.    25 pc.    100 pc.

T434-A4-201    \$199    \$149    \$109    \$89  
T434-A4-302    \$249    \$179    \$129    \$99

## LOW VOLTAGE PIEZOELECTRIC STACKS

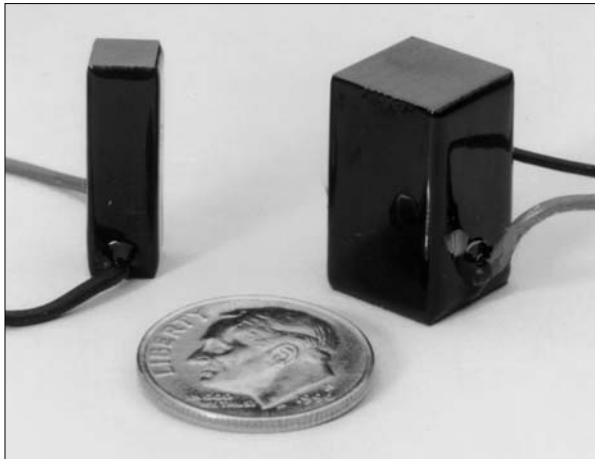

### DESCRIPTION

A low voltage piezoelectric stack is a monolithic ceramic construction of many thin piezoceramic layers which are connected in parallel electrically. The principal characteristics of the stack are: a high energy conversion efficiency, low voltage operation, large force, low motion, fast response, and no EMI.

Motion may be increased, at the expense of force, by mechanical amplification. The stack offers a high energy density in a small package. Due to its superior compressive strength, it provides a high load bearing capability. However, it is relatively weak in tension.

Generally, excitation should be applied only in the direction of polarization.

Hysteresis is typically about 15% in static applications.

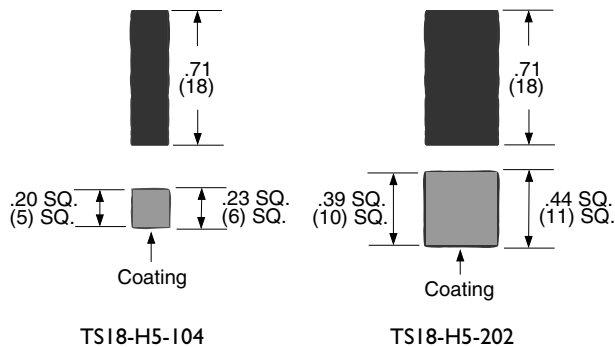

### STACK PERFORMANCE

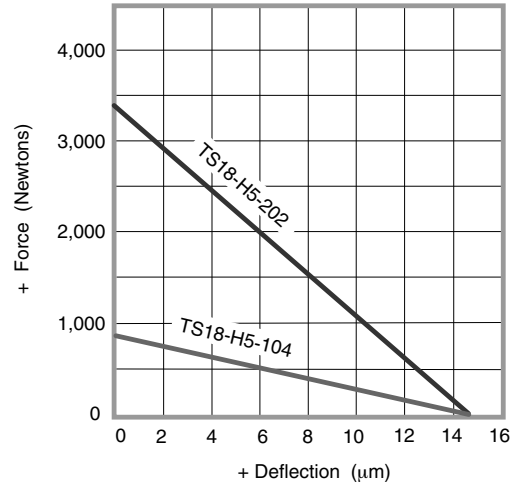

TS18-H5-104 & TS18-H5-202

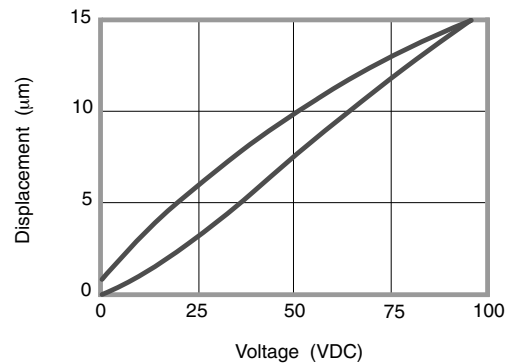

TS18-H5-104

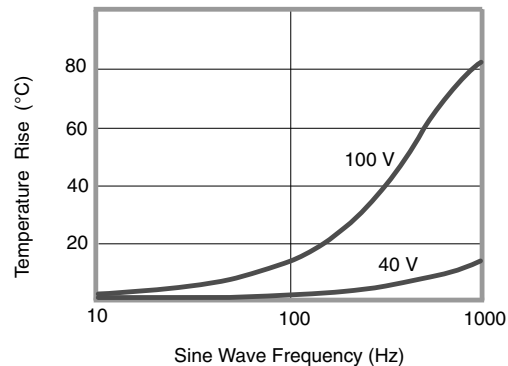

### ORDERING INFORMATION

Low Voltage Piezoelectric Stack (small)  
Low Voltage Piezoelectric Stack (large)

### PART NO.

TS18-H5-104  
TS18-H5-202

### 1 pc.

\$350  
\$499

### 5 pc.

\$300  
\$425

### 25 pc.

\$250  
\$350

### 100 pc.

\$200  
\$275



**SPECIFICATIONS**

**PIEZOELECTRIC STACKS**

		<b>TS18-H5-104</b>	<b>TS18-H5-202</b>
<b>MECHANICAL</b>			
Dimensions (L x W x H)	Inches	0.2 x 0.2 x 0.72	0.4 x 0.4 x 0.72
	mm	5 x 5 x 18	10 x 10 x 18
Compressive Strength	N/m <sup>2</sup>	8.8 x 10 <sup>8</sup>	8.8 x 10 <sup>8</sup>
Tensile Strength	N/m <sup>2</sup>	4.9 x 10 <sup>6</sup>	4.9 x 10 <sup>6</sup>
Young's Modulus	N/m <sup>2</sup>	4.4 x 10 <sup>10</sup>	4.4 x 10 <sup>10</sup>
Poisson Ratio		0.34	0.34
Density	Kg/m <sup>3</sup>	7,900	7,900
Weight	grams	4.5	16.
Wires		.002 x 50 Stranded, Red wire positive	
<b>ELECTRICAL</b>			
Rated Voltage (Positive Only)		+100VDC	+100VDC
Capacitance	nF	1600	6,500
<b>PERFORMANCE (@ =100 VDC)</b>			
Free Deflection	µm	+14.5	+14.5
Blocked Force	N	840	3,388
Resonant Frequency	Hz	74,000	69,000
Stiffness	N/m	5.8 x 10 <sup>7</sup>	2.3 x 10 <sup>8</sup>
Response Time	µs	50	50
<b>ENVIRONMENTAL</b>			
Thermal Operating Range	° C	-20° to +80°	
Thermal Storage Range	° C	-30° to +85°	
Humidity	%	< 50%	

**ROHS:** Compliant. Piezo exempt.

**SOLDER & FLUX KIT**



**KIT INCLUDES:**

- Solder** ■ Lead free solder for nickel electrodes, 12" length.
- Flux** ■ Liquid Flux for soldering to nickel electrodes, and brass & stainless steel center shims, 7 ml.
- Wires** ■ Red wires, #32 Gauge, Stripped & tinned 5" length, 5 pieces.  
■ Black wires, #32 Gauge, Stripped & tinned, 5" length, 5 pieces.
- Small Piezoceramic Sheet**
  - Piezoceramic sheet with nickel electrode to practice technique, 1 piece.
- RoHS Compliant. Piezo exempt.**
  - The materials in the kit are RoHS compliant.

**PURPOSE OF THE KIT**

Soldering wires to the electrodes of piezoceramic sheet and/or the center shim of a 2-layer bending element can be difficult if the proper materials are not used. There is a vast array materials to choose from. The solder & flux kit offers the right materials to get started at once and provides information to procure materials directly from the manufacturer later. Recommended procedure is described. Materials in the kit are for soldering to nickel electrodes.

**DESCRIPTION OF ELECTRODES**

Typically, piezoceramic electrodes are either nickel or fired silver. Nickel electrodes are grey, whereas silver electrodes are flat white in color while

Nickel has good corrosion resistance and is a good choice for both AC and DC applications. It can usually be soldered to easily with lead free solder. Electroless nickel, used for plating piezoceramic, contains phosphor. Sometimes the phosphor content in a plating run can make it hard to solder. Vacuum deposited nickel electrodes are usually very thin, making soldering tricky.

Silver electrodes are not recommended for high electric field DC applications where the silver is likely to migrate and bridge the two electrodes. It is often used in non-magnetic and AC applications. Silver used as an electrode is in the form of flakes suspended in a glass frit. It is generally screened onto the ceramic and fired. The glass makes the bond between the ceramic and the silver particles. Silver is soluble in tin and a silver loaded solder should be used to prevent scavenging of silver in the electrode.

Choice of the correct flux (to remove surface oxidation) generally makes soldering to electrode surfaces easy even under adverse conditions.

**DESCRIPTION OF CENTER SHIMS**

Generally, the center shim layer of a 2-Layer piezoelectric bending element is either brass or stainless steel. A wire is attached to the center shim if the element is used in parallel operation. Shims are soldered in the same way as the nickel electrode. The proper liquid flux choice must be made depending on the shim material.

**ORDERING INFORMATION**

Solder & Flux Kit (For Nickel Electrodes)

**PART NO.**

MSF-003-NI

**1 pc.**

\$49



## INTRODUCTION TO PIEZOELECTRICITY

When a piezoceramic element is stressed electrically by a voltage, its dimensions change. When it is stressed mechanically by a force, it generates an electric charge. If the electrodes are not short-circuited, a voltage associated with the charge appears.

A piezoceramic is therefore capable of acting as either a sensing or transmitting element, or both. Since piezoceramic elements are capable of generating very high voltages, they are compatible with today's generation of solid-state devices — rugged, compact, reliable, and efficient.

The following text describes the terminology of piezoceramics and the relationship among variables for functional applications.

### RELATIONSHIPS

Relationships between applied forces and the resultant responses depend upon: the piezoelectric properties of the ceramic; the size and shape of the piece; and the direction of the electrical and mechanical excitation.

To identify directions in a piezoceramic element, three axes are used. These axes, termed 1, 2 and 3, are analogous to X, Y and Z of the classical three dimensional orthogonal set of axes (Figure 1a)

The polar or 3 axis is taken parallel to the direction of polarization within the ceramic. This direction is established during manufacturing by a high DC voltage that is applied between a pair of electroded faces to activate the material. The polarization vector "P" is represented by an arrow pointing from the positive to the negative poling electrode. In shear operations, these poling electrodes are later removed and replaced by electrodes deposited on a second pair of faces. In this event, the 3 axis is not altered, but is then parallel to the electroded

faces found on the finished element (Figure 1b). When the mechanical stress or strain is shear, the subscript 5 is used in the second place.

Piezoelectric coefficients with double subscripts link electrical and mechanical quantities. The first subscript gives the direction of the electrical field associated with the voltage applied, or the charge produced. The second subscript gives the direction of the mechanical stress or strain.

Several piezoceramic material constants may be written with a "superscript" which specifies either a mechanical or electrical boundary condition. The superscripts are T, E, D and S, signifying:

- T = constant stress  
= mechanically free
- E = constant field = short circuit
- D = constant electrical displacement  
= open circuit
- S = constant strain  
= mechanically clamped

As an example,  $K^T_3$  expresses the relative dielectric constant (K), measured in the polar direction (3) with no mechanical clamping applied.

### "D" CONSTANT

The piezoelectric constants relating the mechanical strain produced by an applied electric field are termed the strain constants, or the "d" coefficients. The units may then be expressed as meters per meter; per volts per meter (meters per volt).

$$d = \frac{\text{strain developed}}{\text{applied electric field}}$$

It is useful to remember that large  $d_{ij}$  constants relate to large mechanical displacements which are usually sought in motional transducer devices. Conversely, the coefficient may be viewed as relating the charge collected on the electrodes, to the applied mechanical stress.  $d_{33}$  applies

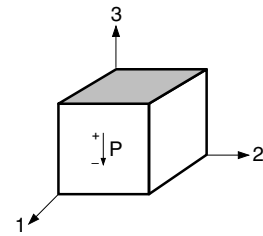

Figure - 1a

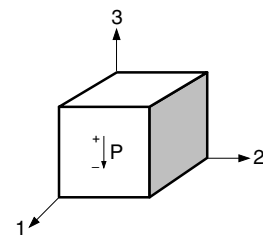

Figure - 1b

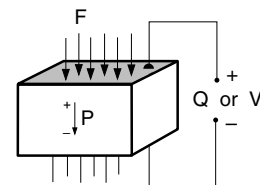

Figure - 2a

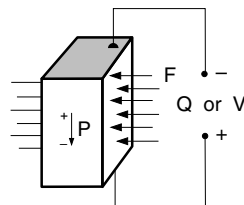

Figure - 2b

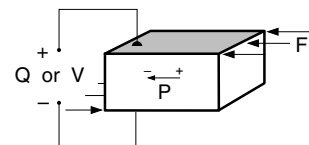

Figure - 2c

when the force is in the 3 direction (along the polarization axis) and is impressed on the same surface on which the charge is collected (Figure 2a).  $d_{31}$  applies when the charge is collected on the same surface as before, but the force is applied at right angles to the polarization axis (Figure 2b).

The subscripts in  $d_{15}$  indicate that the charge is collected on electrodes which are at right angles to the original poling electrodes and that the applied mechanical stress is shear (Figure 2c.)

The units for the  $d_{ij}$  coefficients are commonly expressed as coulombs/square meter per newton/square meter.

$$d = \frac{\text{short circuit charge density}}{\text{applied mechanical stress}}$$

When the force that is applied is distributed over an area which is fully covered by electrodes (even if that is only a portion of the total electrode) the units of area cancel from the equation and the coefficient may be expressed in terms of change per unit force, coulombs per newton. To view the  $d_{ij}$  coefficients in this manner is useful when charge generators are contemplated, e.g., accelerometers.

### “G” CONSTANT

The piezoelectric constants relating the electric field produced by a mechanical stress are termed the voltage constants, or the “g” coefficients. The units may then be expressed as volts/meter per newton/square meter.

$$g = \frac{\text{open circuit electric field}}{\text{applied mechanical stress}}$$

Output voltage is obtained by multiplying the calculated electric field by

the thickness of ceramic between electrodes. A “33” subscript indicates that the electric field and the mechanical stress are both along the polarization axis. (Figure 2a.) A “31” subscript signifies that the pressure is applied at right angles to the polarization axis, but the voltage appears on the same electrodes as in the “33” case. (Figure 2b.)

A “15” subscript implies that the applied stress is shear and that the resulting electric field is perpendicular to the polarization axis. (Figure 2c.)

High  $g_{ij}$  constants favor large voltage output, and are sought after for sensors.

Although the g coefficient are called voltage coefficients, it is also correct to say the  $g_{ij}$  is the ratio of strain developed over the applied charge density with units of meters per meter over coulombs per square meter.

$$g = \frac{\text{strain developed}}{\text{applied charge density}}$$

### DIELECTRIC CONSTANTS

The relative dielectric constant is the ratio of the permittivity of the material,  $\epsilon$ , to the permittivity of free space,  $\epsilon_0$ , in the unconstrained condition, i.e., well below the mechanical resonance of the part.

$$K = \frac{\text{permittivity of material}}{\text{permittivity of free space}} = \frac{\epsilon}{\epsilon_0}$$

### CAPACITANCE

Whereas the relative dielectric constant is strictly a material property, the capacitance is a quantity dependent on the type of material and its dimensions. Capacitance is calculated by multiplying the relative dielectric constant by the permittivity of free space

( $\epsilon_0 = 8.9 \times 10^{-12}$  farads/meter) and electrode surface area, and then dividing by the thickness separating the electrodes. Units are expressed in farads.

$$C = \frac{K \epsilon_0 A}{t}$$

$K_3$  is related to the capacitance between the original poling electrodes.  $K_1$  is related to the capacitance between the second pair of electrodes applied after removal of the poling electrodes for the purposes of shear excitation.

At frequencies far below resonance, piezoelectric ceramic transducers are fundamentally capacitors. Consequently, the voltage coefficients  $g_{ij}$  are related to the charge coefficients  $d_{ij}$  by the dielectric constant  $K_i$  as, in a capacitor, the voltage V is related to the charge Q by the capacitance C. The equations are:

$$\begin{aligned} Q &= CV \\ d_{33} &= K_3^T \epsilon_0 g_{33} \\ d_{31} &= K_3^T \epsilon_0 g_{31} \\ d_{15} &= K_1^T \epsilon_0 g_{15} \end{aligned}$$

### COUPLING COEFFICIENTS

Electromechanical coupling  $k_{33}$ ,  $k_{31}$ ,  $k_p$ , and  $k_{15}$  describe the conversion of energy by the ceramic element from electrical to mechanical form or vice versa. The ratio of the stored converted energy of one kind (mechanical or electrical) to the input energy of the second kind (electrical or mechanical) is defined as the square of the coupling coefficient.

$$k = \sqrt{\frac{\text{mechanical energy stored}}{\text{electrical energy applied}}}$$

or

$$k = \sqrt{\frac{\text{electrical energy stored}}{\text{mechanical energy applied}}}$$

Subscripts denote the relative directions of electrical and mechanical quantities and the kind of motion involved. They can be associated with vibratory modes of certain simple transducer shapes;  $k_{33}$  is appropriate for a long thin bar, electroded on the ends, and polarized along the length, and vibrating in a simple length expansion and contraction.  $k_{31}$  relates to a long thin bar, electroded on a pair of long faces, polarized in thickness, and vibrating in simple length expansion and contraction.  $k_p$  signifies the coupling of electrical and mechanical energy in a thin round disc, polarized in thickness and vibrating in radial expansion and contraction.  $k_{15}$  describes the energy conversion in a thickness shear vibration. Since these coefficients are energy ratios, they are dimensionless.

### YOUNG'S MODULUS

As with all solids, piezoelectric ceramics have mechanical stiffness properties described as Young's Modulus. Young's Modulus is the ratio of stress (force per unit area) to strain (change in length per unit length).

$$Y = \frac{\text{stress}}{\text{strain}}$$

Because mechanical stressing of the ceramic produces an electrical response which opposes the resultant strain, the effective Young's Modulus with electrodes short circuited is lower than with the electrodes open circuited. In addition, the stiffness is different in the 3 direction from that in the 1 or 2 direction. Therefore, in expressing such quantities both direction and electrical conditions must be specified.  $Y_{33}^E$  is the ratio of stress to strain in the 3 direction at constant field E (electrodes shorted).  $Y_{33}^D$  is the equivalent with the electrodes open circuited.  $Y_{11}^E$  and  $Y_{11}^D$  are the moduli in the 1 or 2 direction.  $Y_{55}^E$  and  $Y_{55}^D$  are the ratios of shear stress

to shear strain. Units are usually newtons/square meter.

It should be clearly understood that the piezoceramic properties described above are defined for ideal shapes measured under ideal mechanical and electrical boundary conditions. When put to use under practical device operating conditions, the predicted performance is approached but seldom realized. Non-ideal shapes and non-ideal boundary conditions contribute to transduction losses due to such things as standing waves, interfering vibrational modes, pseudo-clamping, stray electric and dielectric resistances. Since the possibilities are infinite, the designer must evaluate each component under the use conditions for which it is intended.

### DENSITY

The ratio of the mass to volume in the material, expressed in  $\text{kg/m}^3$

$$\rho = \frac{\text{mass}}{\text{volume}}$$

### DISSIPATION FACTOR

A measure of the dielectric losses in the material-defined as the tangent of the loss angle or the ratio of parallel resistance to the parallel reactance, expressed in percent.

### MECHANICAL (QM)

The ratio of reactance to resistance in the equivalent series circuit representing the mechanical vibrating resonant system. The shape of the part affects the value.

### CURIE TEMPERATURE

The temperature at which the crystal structure changes from a non-symmetrical (piezoelectric) to a symmetrical (non-piezoelectric) form, expressed in degrees Celsius.

### AGING RATE

Aging is the attempt of the ceramic to change back to its original state prior to polarization. Aging of piezoelectric ceramics is a logarithmic function with time. The aging rate defines change in the material parameters per decade of time, i.e., 1-10 days, 5-50 days, etc.

### PYROELECTRICITY

Piezoelectric materials are also pyroelectric. They produce electric charge as they undergo a temperature change. When their temperature is increased, a voltage develops having the same orientation as the polarization voltage. When their temperature is decreased, a voltage develops having an orientation opposite to the polarization voltage, creating a depolarizing field with the potential to degrade the state of polarization of the part.

The maximum electric field which arises due to a temperature shift is:

$$E(\text{pyro}) = \frac{\alpha (\Delta T)}{K_3 \epsilon_0}$$

where  $E(\text{pyro})$  is the induced electric field in volts/meter,  $\alpha$  is the pyroelectric coefficient in Coulomb/ $^\circ\text{C meter}^2$ ,  $\Delta T$  is the temperature difference in  $^\circ\text{C}$ ,  $K_3$  is the dielectric constant, and  $\epsilon_0$  is the dielectric permittivity of free space. For PZT piezoceramic,  $\alpha$  is typically  $\sim 400 \times 10^{-6}$  coulomb/ $^\circ\text{C meter}^2$ .

### CRYOGENIC

The piezoelectric strain coefficient decreases significantly at cryogenic temperatures, but does not vanish. At 77°K and 4.2°K the strain coefficient decreases to about 33% and 14% respectively, of its room temperature value. However, the coercive field increases, allowing the piezo to be driven harder.

**MOTOR TRANSDUCER RELATIONSHIPS**

**PARALLEL EXPANSION & CONTRACTION MOTOR**

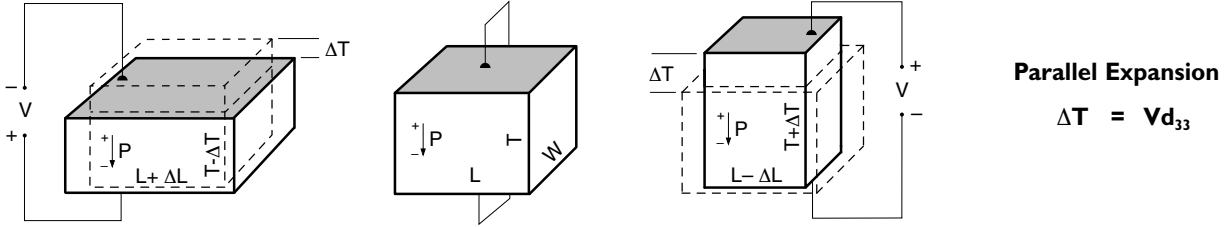

**TRANSVERSE EXPANSION & CONTRACTION MOTOR**

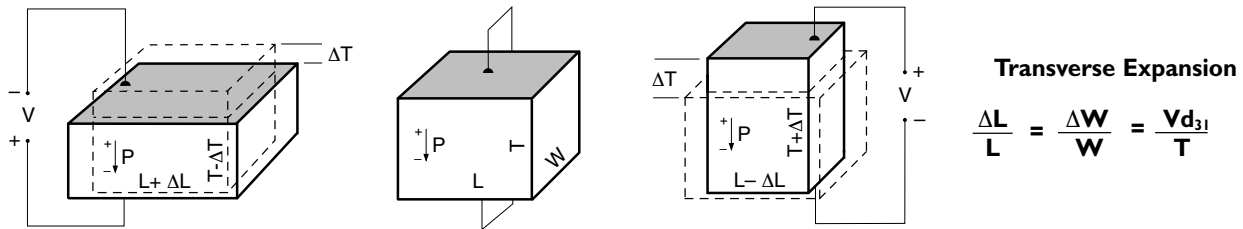

**PARALLEL SHEAR MOTOR**

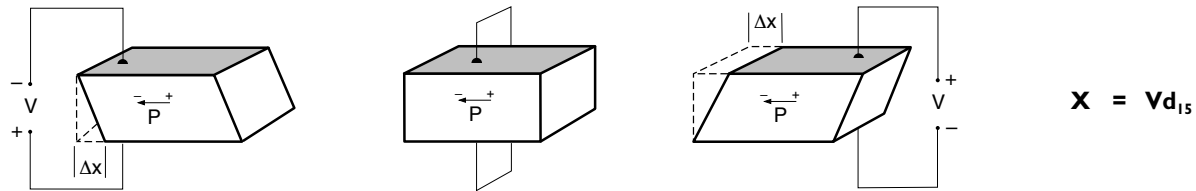

**BENDING MOTOR**

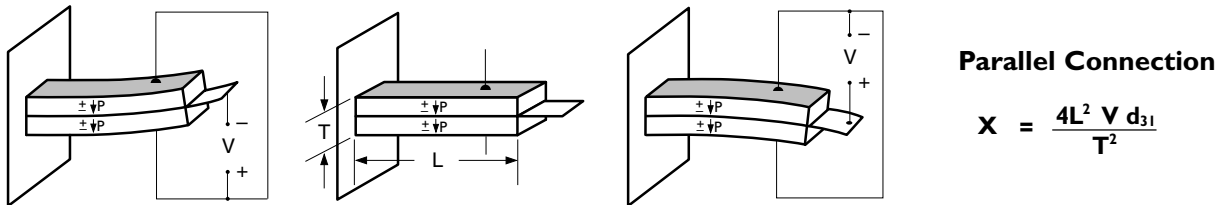
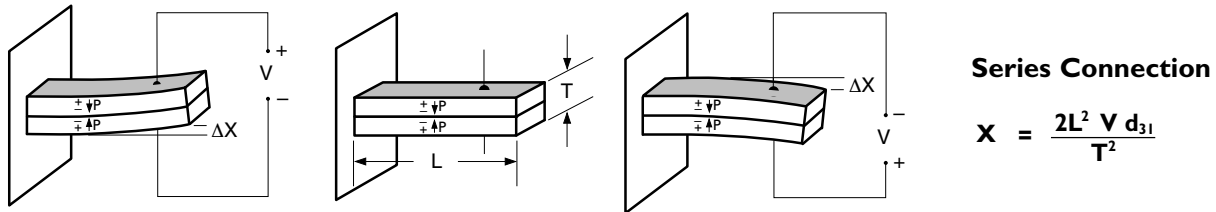

### GENERATOR TRANSDUCER RELATIONSHIPS

#### PARALLEL COMPRESSION OR TENSION GENERATOR

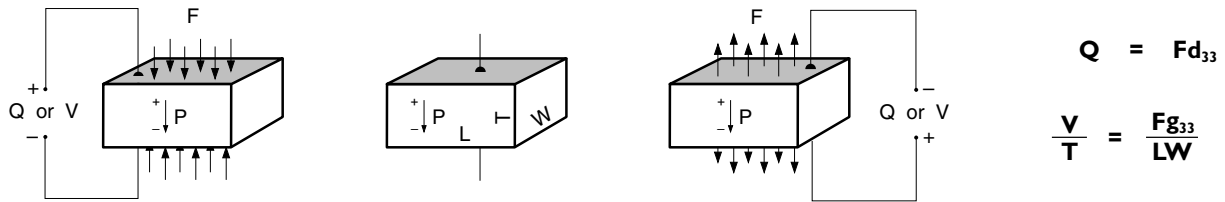

#### TRANSVERSE COMPRESSION OR TENSION GENERATOR

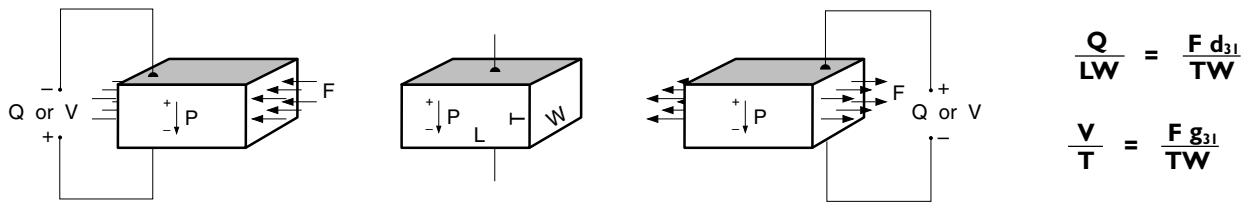

#### PARALLEL SHEAR GENERATOR

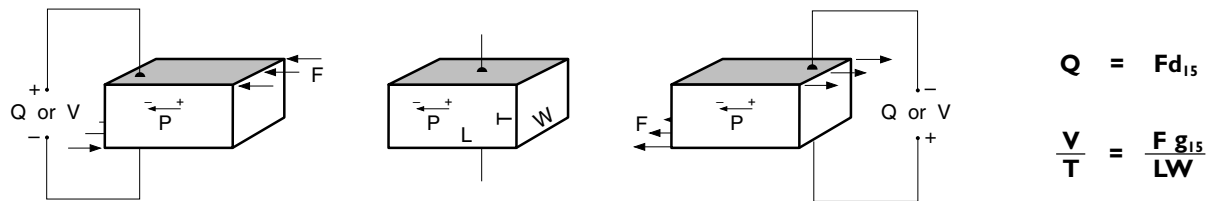

#### TRANSVERSE SHEAR GENERATOR

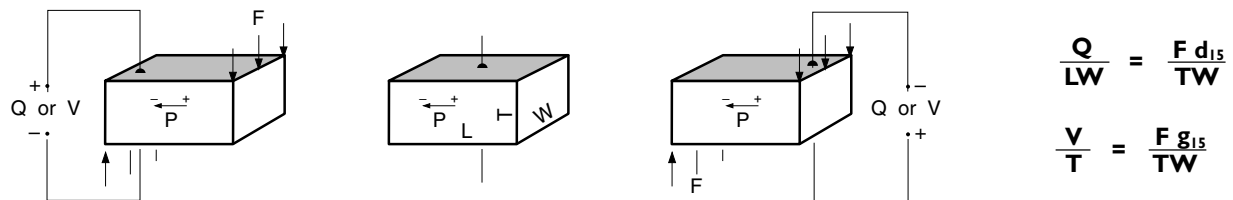

#### BENDING GENERATOR

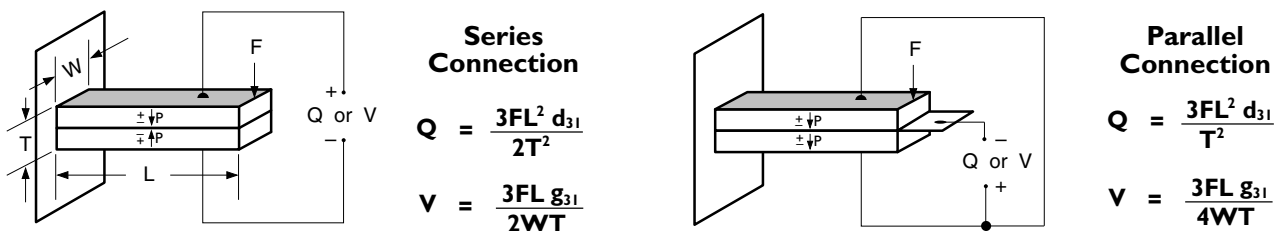

**TYPICAL TEMPERATURE DEPENDENCE OF  
PIEZOCERAMIC PROPERTIES**

